



ANDON
INTERCONNECTION SPECIALISTS



RoHS Compliant
ISO 9001
Certified

IMAGE SENSOR SOCKETS

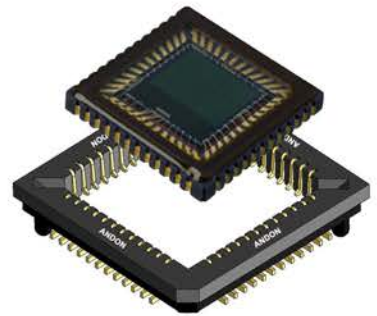
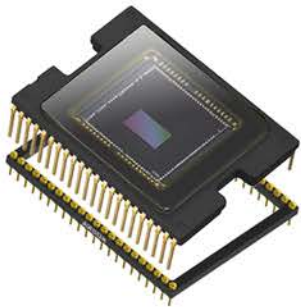

***With Andon's Unique Senstac™ Contact
Maximum Protection and Reliability at Lowest Cost.***

www.andonelect.com or www.andonelectronics.com

Andon has become recognized as the Interconnection Specialist, offering a single, reliable source for IC sockets, micro-precision sockets, adapters, board-to-board interconnects and contact/terminal products. Over the years Andon has set the industry standard for innovation, reliability and superior quality.

Andon's ISO 9001 certified facility offers leading edge tooling, stamping, high-temperature molding, screw machine products and automated assembly capabilities. The result is a line of products, like our Rollerball® Socket technology, that brings true problem solving product process innovation and cost savings to the industry.

Whether you need large or small volume production, stock solutions or custom sockets and interconnects, Andon has the inherently smart, simple and cost-effective solutions to make you more productive.



John O. Tate, Andon President, pioneered many of the innovative, high-reliability interconnects for military, aerospace

and commercial applications that have become industry standards. In 1965, he developed the stamped and formed multi-finger precision IC socket contact, which remains the preferred method throughout the world for connecting today's microprocessors and other critical components.

Image Sensor Sockets For High-Performance CCD-CMOS Sensors

Andon has developed the largest line of Image Sensor Sockets in the industry. We have sockets for Atmel, Dalsa, E2V, Fairchild, Hamamatsu, Kodak/Truesense, Marconi, Micron, Motorola, National, NEC, Peripheral Imaging, Phillips, Site, Sony, Ti, Toshiba, etc...

Image Sensor sockets provide higher reliability because the sockets can be soldered to the motherboard in large quantities.

Lates, as required, the sensors can be plugged-in or unplugged and upgraded easily.

The advantages for using sockets:

- Reduce static discharge (ESD) because of less handling.
- Eliminate soldering temperature which can effect the color array.
- Eliminate need to de-solder CCD-CMOS
- Eliminate cleaning solution, scratches to glass plate and risk blistering PCB
- Eliminate assembly line temperatures, humidity, and shock

Frame Grabber Sockets

- Andon is the industry leader for Rollerball® Ball Grid Array Sockets.
- Contacts are specifically designed for Ball Grid Array Sockets.
- Andon can supply BGA sockets to any footprint.
Contact Andon for price and delivery
- Engineering assistance available.

We produce, in-house, the contact we developed 38 years ago for the aerospace industry, which ensures a reliable source for your needs. Contacts are available in low, Medium, and High Force to suit your requirements.

Andon sockets provide perpendicularity, accurate spacing and interchangeability, while improving quality and reducing cost. Samples are available on request.

Table of Contents

Application Guide _____ 04	ON Semiconductor / Cypress _____ 06	417 .050 [1.27] Pitch SIP Sockets _____ 21
Manufacturer Cross Reference _____ 06	OSI Optoelectronics _____ 10	419 .0437 [1.11] Pitch SIP Sockets _____ 23
Altasens _____ 06	Panavision _____ 10	575 .100 [2.54] Pitch PGA Sockets _____ 16
Aptina - Micron _____ 06	Peripheral _____ 10	585 .050 [1.27] Pitch IBGA Sockets _____ 23
Awaiba _____ 06	Perkin Elmer _____ 10	620 .050 [1.27] Pitch LCC Sockets _____ 25
Cmosis _____ 06	Philips _____ 10	680 .040 [1.01] Pitch LCC Sockets _____ 25
Cypress / ON Semiconductor _____ 06	Samsung _____ 10	685 .0276 [0.70] Pitch LCC Sockets _____ 24
Dalsa / Teledyne _____ 06	SITe _____ 10	690 .0315 [0.80] Pitch LCC Sockets _____ 24
DATEL _____ 07	Sony _____ 10	IS0437 .0437 [1.11] Pitch DIP Sockets _____ 23
e2v _____ 07	Teledyne / Dalsa _____ 11	IS229 .100 [2.54] Pitch DIP Sockets _____ 12
Fairchild _____ 07	Texas Instruments _____ 11	IS229-D .100 [2.54] Pitch Dual DIP Sockets _____ 14
Hamamatsu _____ 07	Toshiba _____ 11	IS230 .070 [1.78] Pitch DIP Sockets _____ 18
Kilburn Isotronics _____ 09	10 .050 [1.27] Pitch IBGA Sockets _____ 22	IS231 .100 [2.54] Pitch DIP Sockets _____ 13
Kodak / Truesense _____ 09	12 .0394 [1.00] Pitch BGA Sockets _____ 24	IS232 .050 [1.27] Pitch DIP Sockets _____ 21
Kyocera _____ 10	18 .0295 [0.75] Pitch BGA Sockets _____ 24	IS233 .070 [1.78] Pitch DIP Sockets _____ 19
Motorola _____ 10	405 .100 [2.54] Pitch SIP Sockets _____ 15	R-Series .225 PC Round Image Sensor Socket _____ 23
National Semiconductor _____ 10	409 .100 [2.54] Pitch Dual SIP Sockets _____ 14	Appendix A: Terminal Details _____ 26
NEC _____ 10	416 .070 [1.78] Pitch SIP Sockets _____ 20	Appendix B: Part Number Index _____ 28

DIP SOCKET PART NUMBERING SYSTEM

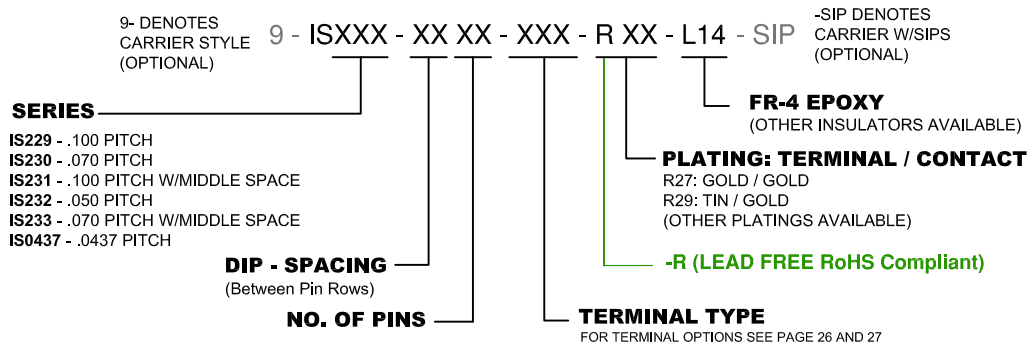

SIP SOCKET PART NUMBERING SYSTEM

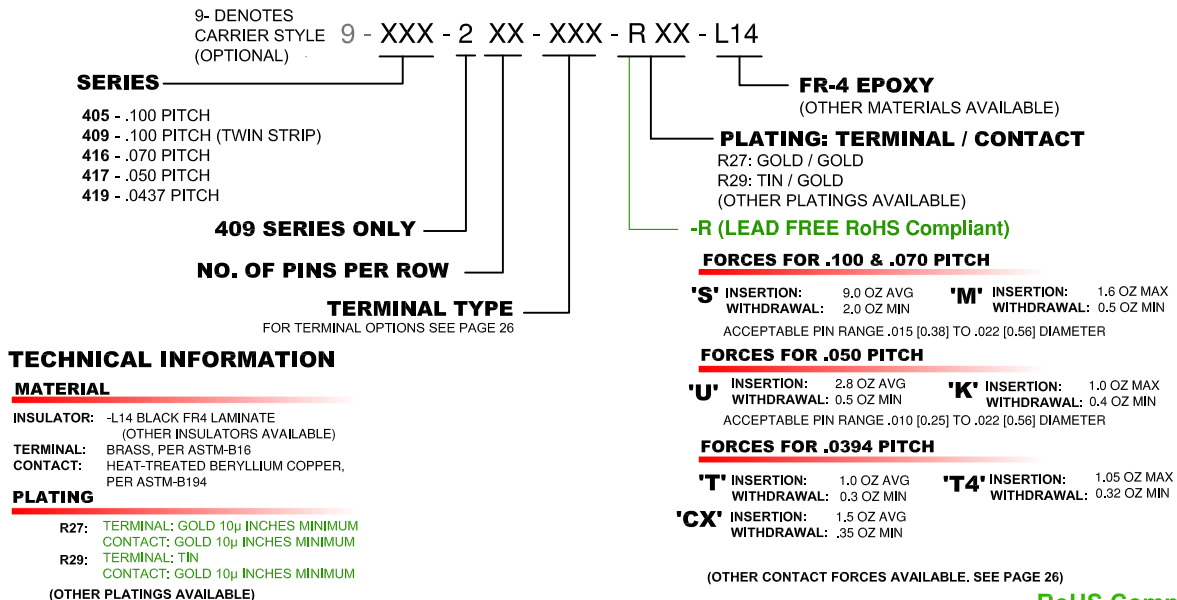

©Copyright 2013 Andon Electronics Corporation. All Rights Reserved. This material is protected under US and other copyrights and may not be copied, sold, or redistributed in any form without written permission of Andon Electronics Corporation. Copyrights and trademarks are property of their respective companies. We reserve the right to change specifications without notice. Andon makes no warranty, expressed or implied, as to the suitability of the sockets for the intended purpose.

RoHS Compliant
Andon Proprietary Information
IS-13A 03/15/13

Image Sensor Socket Applications

[Back to Table of Contents](#)

Image Sensor sockets provide higher reliability because the sockets can be soldered to the motherboard in large quantities. Later, as required, the sensors can be plugged-in or unplugged and upgraded easily.

The advantages for using Image Sensor Sockets:

- Eliminate production line Electro-Static Discharge (ESD) because device is plugged in after all assembly.
- Eliminate soldering temperature which can effect the color array.
- Eliminate the need to de-solder CCD.
- Eliminate cleaning solution, scratches to glass plate and risk blistering PCB.
- Eliminate assembly line temperatures, humidity and shock.

After assembly your device is plugged into a range of available contact forces, built to suit your application. Your circuit boards equipped with our sockets will enable your devices to be interchanged, or replaced in case of damage or upgrade, For more detailed information, contact us at Info@andonelect.com!

Phase 1:

Carrier Assemblies designed to your pin layout arrive at your facility pre-loaded and ready for assembly.



Phase 2:

Carrier Assembly is placed through your soldering process to ensure perpendicularity and coplanarity.



Phase 3:

After soldering, Carrier is removed from the assembly and your device is plugged in.

DIP CARRIER ASSEMBLY

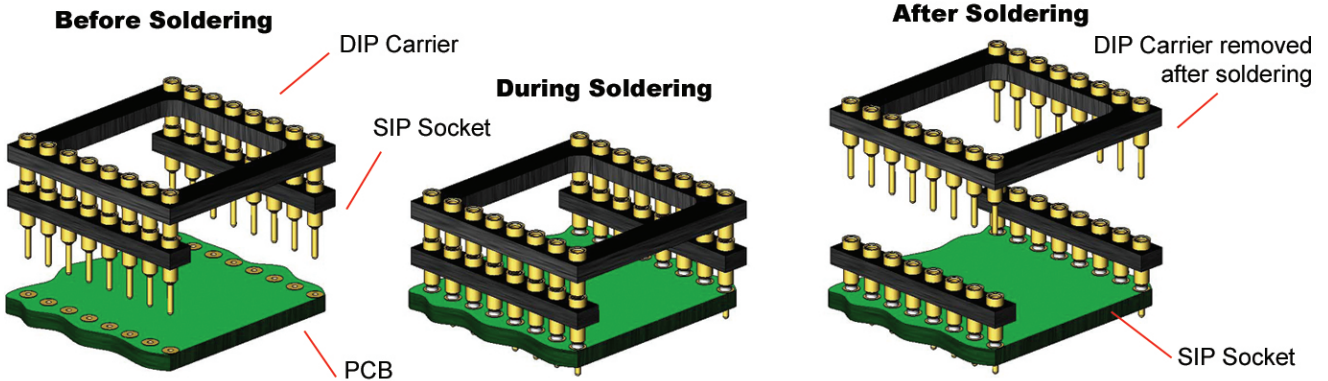

DIP Carrier Assemblies carry two sips through your soldering process to provide a perfectly perpendicular and coplanar socket after soldering. After assembly, DIP carrier is either discarded or sent back to our factory for re-loading.

ULTRA LOW PROFILE SIP CARRIER ASSEMBLY

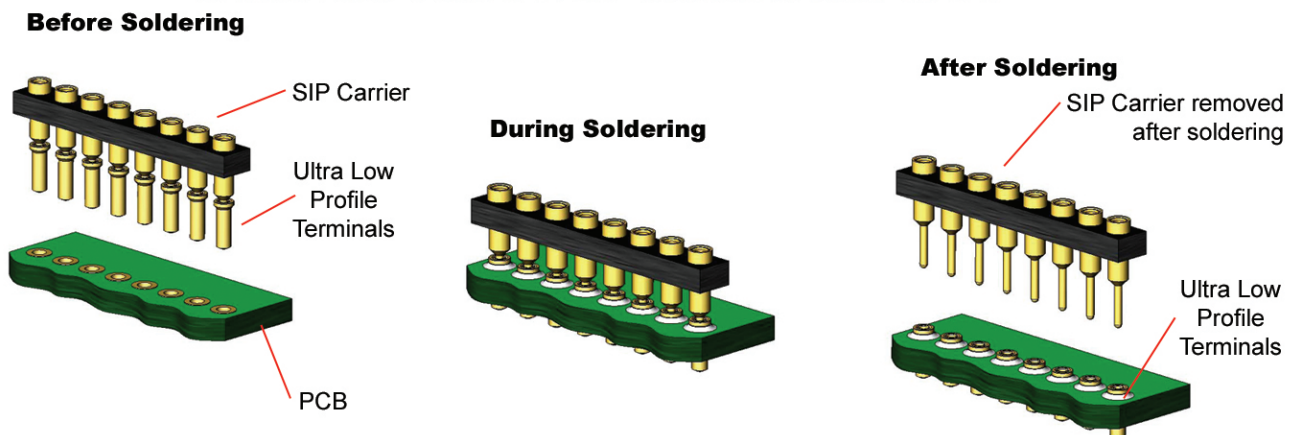

SIP Carrier Assemblies carry ultra low profile terminals through your soldering process to provide a space saving perfectly perpendicular, coplanar, and substrateless socket after soldering. After assembly, SIP carrier is either discarded or sent back to our factory for re-loading.

See Page 26 for Terminal Details and Contact Forces.

Image Sensor Socket Applications ULTRA LOW PROFILE PGA CARRIER ASSEMBLY

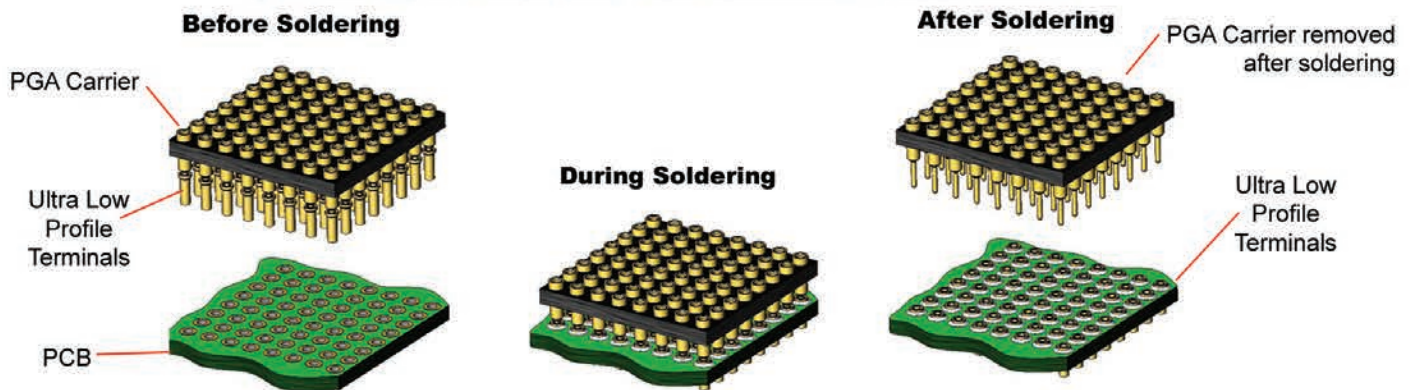

PGA Carrier Assemblies carry ultra low profile terminals through your soldering process to provide a space saving perfectly perpendicular, coplanar, and substrateless socket after soldering. After assembly, the PGA carrier is either discarded or sent back to our factory for re-loading.

ULTRA LOW PROFILE DIP CARRIER ASSEMBLY

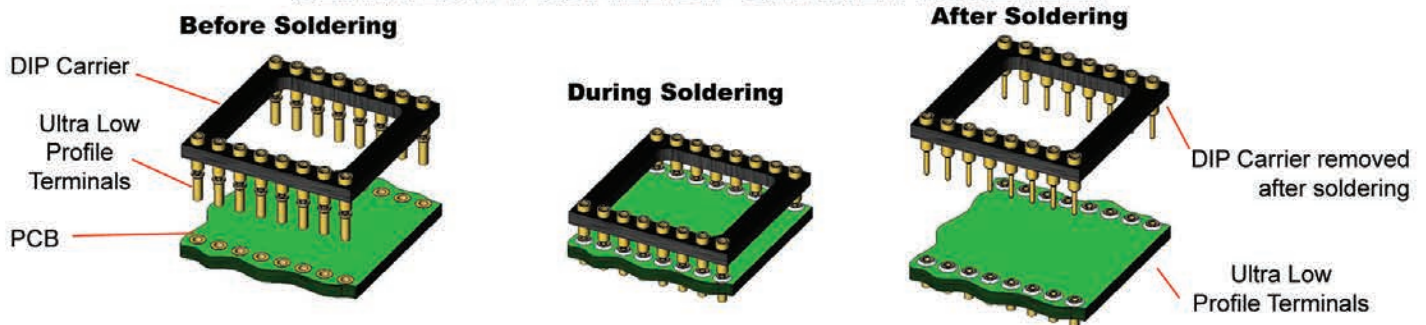

DIP Carrier Assemblies carry ultra low profile terminals through your soldering process to provide a space saving perfectly perpendicular, coplanar, and substrateless socket after soldering. After assembly, the DIP carrier is either discarded or sent back to our factory for re-loading.

Standard Image Sensor Sockets

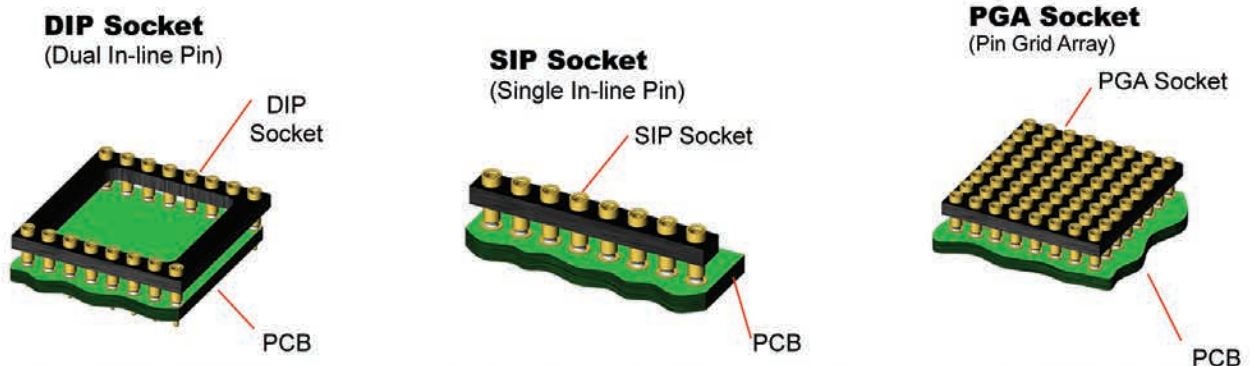

Standard Image Sensor Sockets take the place of your device during the assembly process, saving your devices from unexpected damage, and saving your companies bottom line from unexpected cost as a result. Can be designed to any pin layout or configuration. If your device's layout is not featured in this catalog, contact us at Info@andonelect.com.

See Page 26 for Terminal Details and Contact Forces.

Image Sensor to Socket Cross Reference

[Back to Table of Contents](#)

Atlasens http://www.atlasens.com			
Atlasens Part Number	Andon Part Number	Page	Fig.
2460-1280X720	680-48-SM-G10-R14-X	25	23
2460-1280X1024	680-48-SM-G10-R14-X	25	23
2462-1280X720	680-48-SM-G10-R14-X	25	23
2462-1280X1024	680-48-SM-G10-R14-X	25	23
2463-1280X720	680-48-SM-G10-R14-X	25	23
2463-1280X1024	680-48-SM-G10-R14-X	25	23
2560-1280X720	680-48-SM-G10-R14-X	25	23
2560-1280X1024	680-48-SM-G10-R14-X	25	23
2562-1280X720	680-48-SM-G10-R14-X	25	23
2562-1280X1024	680-48-SM-G10-R14-X	25	23
2563-1280X720	680-48-SM-G10-R14-X	25	23
2563-1280X1024	680-48-SM-G10-R14-X	25	23
3560-1280X720	10-14-11-097-400T4-R27-L14	23	4
3560-1920X1080	10-14-11-097-400T4-R27-L14	23	4
3562-1280X720	10-14-11-097-400T4-R27-L14	23	4
3562-1920X1080	10-14-11-097-400T4-R27-L14	23	4
3570-2080X1170	10-14-11-097-400T4-R27-L14	23	4
HD4562	10-14-11-097-400T4-R27-L14	23	4

Aptina - Micron http://www.aplina.com			
Aptina Part Number	Andon Part Number	Page	Fig.
MT9D131	680-48-SM-G10-R14-X	25	23
MT9E001	685-48-TH-491-R27-L14-X	24	52
MT9J003	685-48-TH-491-R27-L14-X	24	52
MT9J003STC/M	685-48-TH-491-R27-L14-X	24	52
MT9M001	680-48-SM-G10-R14-X	25	23
MT9M001C12STC	680-48-SM-G10-R14-X	25	23
MT9M002	685-48-TH-491-R27-L14-X	24	52
MT9M032	680-48-SM-G10-R14-X	25	23
MT9M131	690-48-SM-G10-L14-X	24	53
MT9M413	575-19-25-281-01M-R29-L14	17	33
MT9M413C36STC	575-19-25-281-01M-R29-L14	17	33
MT9N001	685-48-TH-491-R27-L14-X	24	52
MT9P001	685-48-TH-491-R27-L14-X	24	52
MT9P031	685-48-TH-491-R27-L14-X	24	52
MT9P401	685-48-TH-491-R27-L14-X	24	52
MT9V011	620-28-SM-G10-L14-X	25	23
MT9V011 BGA SOCKET	18-07-03-041-329T-R27-L14	24	50
BGA ADAPTER	18-07-03-041-413-G10-L14	24	50
MT9V022 BGA SOCKET	12-08-02-052-319T-R27-L14	24	51
BGA ADAPTER	12-08-02-052-321-G10-L14	24	51
MT9V023	12-08-02-052-319T-R27-L14	24	51
MT9V024	12-08-02-052-319T-R27-L14	24	51
MT9V030C12ST	680-48-SM-G10-R14-X	25	23
MT9V032	690-48-SM-G10-R14-X	24	53
MT9V033	690-48-SM-G10-R14-X	24	53
MT9V043_00STC	680-48-SM-G10-R14-X	25	23
MT9V403	680-48-SM-G10-R14-X	25	23

Awaiba http://www.awaiba.com			
Awaiba Part Number	Andon Part Number	Page	Fig.
DR-2k-7LCC	690-90-SM-G10-L14-X	24	70
DR-2x4k-7LCC	690-90-SM-G10-L14-X	24	70
DR-4k-3.5LCC	690-90-SM-G10-L14-X	24	70
XF-768	620-44-SM-G10-L14-X	25	23

Cmosis http://www.cmosis.com/			
Cmosis Part Number	Andon Part Number	Page	Fig.
CMV2000	10-12-06-095-400T4-R27-L14	23	47
CMV4000	10-12-06-095-400T4-R27-L14	23	47
CMV12000 Pkg. 01	10-30-07-237-405-G10-L14	22	48
CMV12000 Pkg. 02	10-30-07-237-400T4-R27-L14	22	48

Cypress / ON Semiconductor http://www.cypress.com/				
Cypress / ON Semiconductor Part #	Cypress / ON Semiconductor Base \ Root Part	Andon Part Number	Page	Fig.
NOI42SM1000A	HAS 2	710-84-SM-T1	25	57
NOI4SM014KA	IBIS4 14000	IS231-1149D-01M-R29-L14	14	37
NOI4SM014KA-GEC	IBIS4 14000	IS231-1149D-01M-R29-L14	14	37
CYI4SM1300AA	IBIS4 1300	680-84-SM-G10-R14-X	25	23
NOI4SM6600A	IBIS4-6600	620-68-SM-G10-L14-X	25	23
NOI4SM6600AB JLCC	IBIS4-6600	710-84-SM-T1	25	57
NOI1SM0300A	LUPA-300	680-48-SM-G10-R14-X	25	23
NOI2SM1300A	LUPA-1300	575-16-24-127-01M-R29-L14	17	35
NOI1SN3000A	LUPA 3000	10-21-06-369-400T4-R27-L14	23	55
NOI1SM4000A	LUPA-4000	575-16-24-127-01M-R29-L14	17	35
CYIL2SM1300AA	LUPA 1300-2	10-24-05-168-400T4-R27-L14	22	5
NOIS1SM0250A	STAR 250	710-84-SM-T1	25	57
NOIS1SM1000A	STAR1000	710-84-SM-T1	25	57
NOIV1SM025KA	VITA 25K	10-31-13-355-400T4-R27-L14	22	56
NOIV1SE025KA	VITA 25K	10-31-13-355-400T4-R27-L14	22	56
NOIV1SN1300A	VITA 1300	680-48-SM-G10-R14-X	25	23
NOIV2SN1300A	VITA 1300	680-48-SM-G10-R14-X	25	23
NOIV1SN2000A	VITA 2K	620-52-SM-G10-L14-X	25	23
NOIV2SN2000A	VITA 2K	620-52-SM-G10-L14-X	25	23
NOIV1SN5000A	VITA 5K	620-68-SM-G10-L14-X	25	23
NOIV1SE5000A	VITA 5K	620-68-SM-G10-L14-X	25	23

Dalsa / Teledyne http://www.teledynedalsa.com			
Dalsa Part Number	Andon Part Number	Page	Fig.
1T-G3-2048	IS229-780D-01M-R29-L14	14	3
DCI0605C	680-32-SM-G10-L14-X	25	23
FT18	IS230-632-75S-R29-L14	18	6
FT50M	IS232-628-274U-R27-L14	21	8
FTF2020M	575-15-65-084-01M-R29-L14	16	24
FTF2021M	575-15-65-084-01M-R29-L14	16	24
FTF2416C	620-40A-SM-G10-L14-X	25	23
FTF2416M	620-40A-SM-G10-L14-X	25	23
FTF3020C	575-20-16-096-01M-R29-L14	16	22
FTF3020C-HS	575-20-16-096-01M-R29-L14	16	22
FTF3020M	575-20-16-096-01M-R29-L14	16	22
FTF3021M	575-20-16-096-01M-R29-L14	16	22
FTF3041M	575-25-04-080-01M-R29-L14	16	25
FTF4027C	575-20-16-096-01M-R29-L14	16	22
FTF4027M	575-20-16-096-01M-R29-L14	16	22
FTF4052C	575-25-04-080-01M-R29-L14	16	25
FTF4052M	575-25-04-080-01M-R29-L14	16	25
FTF5033C	575-20-16-096-01M-R29-L14	16	22
FTF5033M	575-20-16-096-01M-R29-L14	16	22
FTF5066C	575-25-04-080-01M-R29-L14	16	25
FTF5066M	575-25-04-080-01M-R29-L14	16	25
FTF6146C	575-23-02-104-01M-R29-L14	17	28
FTF6146M	575-23-02-104-01M-R29-L14	17	28
FTF7040M	575-40-02-104-01M-R29-L14	17	26
FTT1010M	575-15-63-080-01M-R29-L14	16	20
IA-D1-0128	IS229-624-01S-R29-L14	12	1
IA-D1-0256	IS229-624-01S-R29-L14	12	1
IA-DJ-01044	IS229-1639D-80M-R29-L14	14	3
IA-DJ-02084	IS229-2239-01S-R29-L14	13	61
IA-DJ-05524	IS229-1639D-80S-R29-L14	14	3
IA-DJ-00524	IS229-1639D-80S-R29-L14	14	3
IL-C6-2048	IS229-324-01S-R29-L14	12	1
IL-E2-0512	IS229-324-01S-R29-L14	12	1
IL-E2-1024	IS229-324-01S-R29-L14	12	1
IL-E2-2048	IS229-324-01S-R29-L14	12	1
IL-F7-0512	IS232-440-274U-R27-L14	21	8
IL-F7-1024	IS232-440-274U-R27-L14	21	8
IL-F7-2048	IS232-440-274U-R27-L14	21	8

* Replace "X" with "0" for without index pin, or "1" for index pin

For Other Pin Configuration or Layouts, Contact Factory.

Image Sensor to Socket Cross Reference

[Back to Table of Contents](#)

Dalsa / Teledyne continue http://www.teledynedalsa.com			
Dalsa Part Number	Andon Part Number	Page	Fig.
IL-P1-0512	IS230-532-75S-R29-L14	18	6
IL-P1-1024	IS230-532-75S-R29-L14	18	6
IL-P1-2048	IS230-532-75S-R29-L14	18	6
IL-P1-4096	IS233-532-75S-R29-L14	19	9
IL-P3-B-0512	IS229-324-01S-R29-L14	12	1
IL-P3-B-1024	IS229-324-01S-R29-L14	12	1
IL-P3-B-2048	IS229-324-01S-R29-L14	12	1
IT-F6-2048B	IS229-650-01M-R29-L14	12	1
IT-P1-1024	IS230-532-75S-R29-L14	18	6
IT-P1-2048	IS230-532-75S-R29-L14	18	6
IT-P1-4096	IS233-532-75S-R29-L14	19	9
IT-P4-6144	IS233-532-75S-R29-L14	19	9
IT-P4-8192	IS233-532-75S-R29-L14	19	9

DATEL http://www.date1.com			
DATEL Part Number	Andon Part Number	Page	Fig.
ADCDS-1405	IS229-940-01M-R29-L14	12	1

e2v http://www.e2v.com			
e2v Part Number	Andon Part Number	Page	Fig.
AT71200M	575-19-27-088-01M-R29-L14	17	27
AT71201M	IS229-2488D-01M-R29-L14	14	3
CCD02-06dd	IS229-620-01S-R29-L14	12	1
CCD02-06ims	IS229-620-01S-R29-L14	12	1
CCD05-20ims	IS229-1644D-01M-R29-L14	14	3
CCD05-20sis	IS229-1644D-01M-R29-L14	14	3
CCD05-20-Y	IS229-1644D-01M-R29-L14	14	3
CCD05-30ims	IS229-1944D-01M-R29-L14	14	3
CCD05-30sis	IS229-1944D-01M-R29-L14	14	3
CCD30-11BI	IS229-6120-80S-R29-L14	12	1
CCD30-11dd	IS229-6120-80S-R29-L14	12	1
CCD30-11DDS	IS229-6120-80S-R29-L14	12	1
CCD30-11IMS	IS229-6120-80S-R29-L14	12	1
CCD30-11ims	IS229-6120-80S-R29-L14	12	1
CCD30-11OE	IS229-6120-80S-R29-L14	12	1
CCD30-11oe	IS229-6120-80S-R29-L14	12	1
CCD31-20	IS229-624-01S-R29-L14	12	1
CCD39-01BI	IS229-6124-01S-R29-L14	12	1
CCD39-02BI	IS229-6124-01S-R29-L14	12	1
CCD42-10BI	IS229-6120-80S-R29-L14	12	1
CCD42-10IMS	IS229-6120-80S-R29-L14	12	1
CCD42-40aimo	IS229-1824-80S-R29-L14	12	1
CCD42-40C_AIMO_BI	IS229-1824-80S-R29-L14	12	1
CCD42-40FI_AIMO_CCP	IS229-1824-80S-R29-L14	12	1
CCD42-40FI_NIMO_CCP	IS229-1824-80S-R29-L14	12	1
CCD42-40nimo	IS229-1824-80S-R29-L14	12	1
CCD42-40NIMO_BI	IS229-1824-80S-R29-L14	12	1
CCD42-90bi	575-08-04-040-80M-R29-L14	16	14
CCD44-82	575-08-04-040-80M-R29-L14	16	14
CCD47-10	IS229-932-01S-R29-L14	12	1
CCD47-10aibt	IS229-924-01S-R29-L14	12	1
CCD47-10aimo	IS229-924-01S-R29-L14	12	1
CCD47-10AIMO_CP	IS229-924-01S-R29-L14	12	1
CCD47-10BT	IS229-932-01S-R29-L14	12	1
CCD47-10BTCP	IS229-924-01S-R29-L14	12	1
CCD47-10nibt	IS229-924-01S-R29-L14	12	1
CCD47-10nimo	IS229-924-01S-R29-L14	12	1
CCD47-10NIMO_BTCP	IS229-924-01S-R29-L14	12	1
CCD47-10NIMO_CP	IS229-924-01S-R29-L14	12	1
CCD47-20	IS229-932-01S-R29-L14	12	1
CCD47-20AIMO	IS229-932-01S-R29-L14	12	1
CCD47-20BT	IS229-932-01S-R29-L14	12	1
CCD47-20BT_NIMO	IS229-932-01S-R29-L14	12	1
CCD48-20BI_NIMO	IS229-932-01S-R29-L14	12	1
CCD55-20IMS	IS229-1644D-01M-R29-L14	14	3

For Other Pin Configuration or Layouts, Contact Factory.

©Copyright 2013 Andon Electronics Corporation. All Rights Reserved. This material is protected under US and other copyrights and may not be copied, sold, or redistributed in any form without written permission of Andon Electronics Corporation. Copyrights and trademarks are property of their respective companies. We reserve the right to change specifications without notice. Andon makes no warranty, expressed or implied, as to the suitability of the sockets for the intended purpose.

ANDON ELECTRONICS CORPORATION
4 Court Drive, Lincoln RI 02865, United States of America

e2v continue http://www.e2v.com			
e2v Part Number	Andon Part Number	Page	Fig.
CCD55-20IMS_BI	IS229-1644D-01M-R29-L14	14	3
CCD55-30	IS229-1944D-01M-R29-L14	14	3
CCD55-30BI	IS229-1944D-01M-R29-L14	14	3
CCD55-30IMS	IS229-1944D-01M-R29-L14	14	3
CCD57-10	IS229-932-01S-R29-L14	12	1
CCD57-10AIMO_BTCP	IS229-924-01S-R29-L14	12	1
CCD60 F/BI	IS229-624-01S-R29-L14	12	1
CCD60 Peltier FI	IS230-1232-75S-R29-L14	18	6
CCD62-06IMS	IS229-620-01S-R29-L14	12	1
CCD65	575-10-19-037-01S-R29-L14	17	30
CCD65 Peltier	IS230-1232-75S-R29-L14	18	6
CCD67BI_NIMO	IS229-924-01S-R29-L14	12	1
CCD67FI_NIMO	IS229-932-01S-R29-L14	12	1
CCD67FL_NIMO_CP	IS229-924-01S-R29-L14	12	1
CCD77-00BI	IS229-924-01S-R29-L14	12	1
CCD77-00FI	IS229-924-01S-R29-L14	12	1
CCD97 BI 2P IMO	IS230-930-75S-R29-L14	18	6
CCD97 FI 2P IMO	IS230-930-75S-R29-L14	18	6
CCD97 Peltier BI2PIMO	IS230-1232-75S-R29-L14	18	6
CCD97 Peltier FI2PIMO	IS230-1232-75S-R29-L14	18	6
CCD201-20 BI	575-14-39-036-01S-R29-L14	17	29
CCD201-20 FI	575-14-39-036-01S-R29-L14	17	29
CCD230-42	IS229-2278T-01M-R29-L14	13	42
CCD230-84 FI	IS229-3080D-01M-R29-L14	14	3
TH7804ACC	IS229-624-80S-R29-L14	12	1
TH7813A	IS229-420-01S-R29-L14	12	1
TH7814A	IS229-420-01S-R29-L14	12	1
TH7815A	IS229-420-01S-R29-L14	12	1
TH7817A	IS229-420-01S-R29-L14	12	1
TH7818A	IS229-420-01S-R29-L14	12	1
TH7819A	IS229-420-01S-R29-L14	12	1
TH7834CCC-RB	IS229-656-01M-R29-L14	12	1
TH7841ACC	IS229-628-80S-R29-L14	12	1
TH7888A	409-210-80S-R29-L14	14	11
TH7891M	575-16-26-032-01S-R29-L14	17	46
TH7899M	575-15-62-082-80M-R29-L14	16	19

Fairchild http://www.fairchildsemi.com			
Fairchild Part Number	Andon Part Number	Page	Fig.
CCD111ADC	IS229-318-01S-R29-L14	12	1
CCD111BDC	IS229-318-01S-R29-L14	12	1
CCD133ADC	IS229-624-80S-R29-L14	12	1
CCD134	IS229-624-80S-R29-L14	12	1
CCD143ADC	IS229-628-80S-R29-L14	12	1
CCD153ADC	IS229-624-80S-R29-L14	12	1
CCD181DC	IS229-628-80S-R29-L14	12	1
CCD191DC	IS229-640-01M-R29-L14	12	1
CCD3041	585-18-12-046-211M-R29-L14	23	64
CCD3041 BI	585-18-12-046-211M-R29-L14	23	64
CCD3041 FI	585-18-12-046-211M-R29-L14	23	64
CCD424	575-23-03-072-01M-R29-L14	16	62
CCD485	575-21-14-168-80M-R29-L14	16	61
CCD486 FI	IS229-2654-01M-R29-L14	12	1
CCD486 BI	IS231-2054D-01M-R29-L14	16	63
CCD5045	IS229-648-01M-R29-L14	12	1
CCD5061	IS229-10264T-01M-R29-L14-A	15	66
CCD525	IS229-840-01M-R29-L14	12	1
CCD8091	IS229-8176D-01M-R29-L14-A	15	65
CMOC1421 (LCC)	Contact Factory	N/A	N/A

Hamamatsu http://www.hamamatsu.com			
Hamamatsu Part Number	Andon Part Number	Page	Fig.
G8050-256R	IS229-828-88S-R29-L14	12	1
G8050-256S	IS229-828-88S-R29-L14	12	1
G8051-512R	IS229-828-88S-R29-L14	12	1
G8051-512S	IS229-828-88S-R29-L14	12	1

RoHS Compliant
Andon Proprietary Information
IS-13A 03/15/13

www.andonelectronics.com or www.andonelect.com
Phone 401-333-0388 Fax 401-333-0287
Email Info@andonelect.com

Image Sensor to Socket Cross Reference

[Back to Table of Contents](#)

Hamamatsu continue http://www.hamamatsu.com			
Hamamatsu Part Number	Andon Part Number	Page	Fig.
G8052-256R	IS229-828-88S-R29-L14	12	1
G8052-256S	IS229-828-88S-R29-L14	12	1
G8053-512R	IS229-828-88S-R29-L14	12	1
G8053-512S	IS229-828-88S-R29-L14	12	1
G8160-256S	IS229-828-88S-R29-L14	12	1
G8161-512S	IS229-828-88S-R29-L14	12	1
G8180-256W	IS229-828-88S-R29-L14	12	1
G9201-256	IS229-826-01S-R29-L14	12	1
G9201-512S	IS229-828-01S-R29-L14	12	1
G9202-521S	IS229-826-01S-R29-L14	12	1
G9203-256D	IS229-826-01S-R29-L14	12	1
G9203-256S	IS229-826-01S-R29-L14	12	1
G9204-512D	IS229-826-01S-R29-L14	12	1
G9205-256W	IS229-828-01S-R29-L14	12	1
G9206-256W	IS229-828-01S-R29-L14	12	1
G9207-256W	IS229-828-01S-R29-L14	12	1
G9208-256W	IS229-828-01S-R29-L14	12	1
G9211-256S	IS229-828-01S-R29-L14	12	1
G9212-512S	IS229-828-01S-R29-L14	12	1
G9213-256S	IS229-828-01S-R29-L14	12	1
G9214-512S	IS229-828-01S-R29-L14	12	1
G9494-256D	IS229-422-01S-R29-L14	12	1
G9494-512D	IS229-622-01S-R29-L14	12	1
G10768 Series	IS229-944-01M-R29-L14	12	1
S10077	IS229-424-01S-R29-L14	12	1
S10140-1007	IS229-924-01S-R29-L14	12	1
S10140-1008	IS229-924-01S-R29-L14	12	1
S10140-1009	IS229-924-01S-R29-L14	12	1
S10140-1107	IS229-924-01S-R29-L14	12	1
S10140-1108	IS229-924-01S-R29-L14	12	1
S10140-1109	IS229-924-01S-R29-L14	12	1
S10141-1007	IS229-924-01S-R29-L14	12	1
S10141-1007S	IS229-924-01S-R29-L14	12	1
S10141-1008	IS229-924-01S-R29-L14	12	1
S10141-1008S	IS229-924-01S-R29-L14	12	1
S10141-1009	IS229-924-01S-R29-L14	12	1
S10141-1009S	IS229-924-01S-R29-L14	12	1
S10141-1107	IS229-924-01S-R29-L14	12	1
S10141-1107S	IS229-924-01S-R29-L14	12	1
S10141-1108	IS229-924-01S-R29-L14	12	1
S10141-1108S	IS229-924-01S-R29-L14	12	1
S10141-1109	IS229-924-01S-R29-L14	12	1
S10141-1109S	IS229-924-01S-R29-L14	12	1
S10201-04	IS232-440-274U-R27-L14	21	8
S10420-01 Series	IS229-39524-01S-R29-L14	12	1
S10420-1006	IS229-424-01S-R29-L14	12	1
S10420-1106	IS229-424-01S-R29-L14	12	1
S11071 Series	IS229-39524-01S-R29-L14	12	1
S11108	IS229-424-01S-R29-L14	12	1
S11155-2048	IS229-39524-01S-R29-L14	12	1
S11156-2048	IS229-39524-01S-R29-L14	12	1
S11500-1007	IS229-8824-01S-R29-L14	12	1
S3091-512FX	IS229-422-01S-R29-L14	12	1
S3901-128Q	IS229-422-01S-R29-L14	12	1
S3901-256F	IS229-422-01S-R29-L14	12	1
S3901-256FX	IS229-422-01S-R29-L14	12	1
S3901-256Q	IS229-422-01S-R29-L14	12	1
S3901-512F	IS229-422-01S-R29-L14	12	1
S3901-512Q	IS229-422-01S-R29-L14	12	1
S3901-1024Q	IS231-622-01S-R29-L14	13	7
S3902-128Q	IS229-422-01S-R29-L14	12	1
S3902-256Q	IS229-422-01S-R29-L14	12	1

Hamamatsu continue http://www.hamamatsu.com			
Hamamatsu Part Number	Andon Part Number	Page	Fig.
S3902-512Q	IS229-422-01S-R29-L14	12	1
S3903-256Q	IS229-422-01S-R29-L14	12	1
S3903-512Q	IS229-422-01S-R29-L14	12	1
S3903-1024Q	IS229-422-01S-R29-L14	12	1
S3904-256Q	IS229-422-01S-R29-L14	12	1
S3904-512F	IS229-422-01S-R29-L14	12	1
S3904-512Q	IS229-422-01S-R29-L14	12	1
S3904-1024F	IS229-422-01S-R29-L14	12	1
S3904-1024Q	IS229-422-01S-R29-L14	12	1
S3904-2048Q	IS231-622-01S-R29-L14	13	7
S3921-128Q	IS229-422-01S-R29-L14	12	1
S3921-256Q	IS229-422-01S-R29-L14	12	1
S3921-512Q	IS229-422-01S-R29-L14	12	1
S3922-128Q	IS229-422-01S-R29-L14	12	1
S3922-256Q	IS229-422-01S-R29-L14	12	1
S3922-512Q	IS229-422-01S-R29-L14	12	1
S3923-256Q	IS229-422-01S-R29-L14	12	1
S3923-512Q	IS229-422-01S-R29-L14	12	1
S3923-1024Q	IS229-422-01S-R29-L14	12	1
S3924-256Q	IS229-422-01S-R29-L14	12	1
S3924-512Q	IS229-422-01S-R29-L14	12	1
S3924-1024Q	IS229-422-01S-R29-L14	12	1
S5930-256S	IS229-622-01S-R29-L14	12	1
S5930-512S	IS229-624-01S-R29-L14	12	1
S5931-512S	IS229-622-01S-R29-L14	12	1
S5931-1024S	IS229-624-01S-R29-L14	12	1
S7010-0906	IS229-424-80S-R29-L14	12	1
S7010-0907	IS229-424-80S-R29-L14	12	1
S7010-0908	IS229-624-80S-R29-L14	12	1
S7010-1006	IS229-424-80S-R29-L14	12	1
S7010-1007	IS229-424-80S-R29-L14	12	1
S7010-1008	IS229-624-80S-R29-L14	12	1
S7011-0906	IS229-624-80S-R29-L14	12	1
S7011-0907	IS229-624-80S-R29-L14	12	1
S7011-1006	IS229-624-80S-R29-L14	12	1
S7011-1007	IS229-624-80S-R29-L14	12	1
S7015-0908	IS229-9124-80S-R29-L14	12	1
S7015-1008	IS229-9124-80S-R29-L14	12	1
S7017-1007	IS229-2024-80S-R29-L14	12	1
S7017-1008	IS229-2024-80S-R29-L14	12	1
S7018-1010	575-13-83-048-80M-R29-L14	16	18
S7019-1009	575-13-83-048-80M-R29-L14	16	18
S7030-0906	IS229-924-01S-R29-L14	12	1
S7030-0907	IS229-924-01S-R29-L14	12	1
S7030-0908	IS229-924-01S-R29-L14	12	1
S7030-1006	IS229-924-01S-R29-L14	12	1
S7030-1007	IS229-924-01S-R29-L14	12	1
S7030-1008	IS229-924-01S-R29-L14	12	1
S7031-0906	IS229-924-01S-R29-L14	12	1
S7031-0906S	IS229-924-01S-R29-L14	12	1
S7031-0907	IS229-924-01S-R29-L14	12	1
S7031-0907S	IS229-924-01S-R29-L14	12	1
S7031-0908	IS229-924-01S-R29-L14	12	1
S7031-0908S	IS229-924-01S-R29-L14	12	1
S7031-1006	IS229-924-01S-R29-L14	12	1
S7031-1006S	IS229-924-01S-R29-L14	12	1
S7031-1007	IS229-924-01S-R29-L14	12	1
S7031-1007S	IS229-924-01S-R29-L14	12	1
S7031-1008	IS229-924-01S-R29-L14	12	1
S7031-1008S	IS229-924-01S-R29-L14	12	1
S7033-0907	IS229-924-01S-R29-L14	12	1

For Other Pin Configuration or Layouts, Contact Factory.

RoHS Compliant

Andon Proprietary Information

IS-13A 03/15/13

©Copyright 2013 Andon Electronics Corporation. All Rights Reserved. This material is protected under US and other copyrights and may not be copied, sold, or redistributed in any form without written permission of Andon Electronics Corporation. Copyrights and trademarks are property of their respective companies. We reserve the right to change specifications without notice. Andon makes no warranty, expressed or implied, as to the suitability of the sockets for the intended purpose.

Image Sensor to Socket Cross Reference

[Back to Table of Contents](#)

Hamamatsu continue http://www.hamamatsu.com			
Hamamatsu Part Number	Andon Part Number	Page	Fig.
S7033-1007	IS229-924-01S-R29-L14	12	1
S7034-0907	IS229-924-01S-R29-L14	12	1
S7034-0907S	IS229-924-01S-R29-L14	12	1
S7034-1007	IS229-924-01S-R29-L14	12	1
S7034-1007S	IS229-924-01S-R29-L14	12	1
S7170-0909	IS229-924-01S-R29-L14	12	1
S7171-0909	IS229-924-01S-R29-L14	12	1
S7199-01	IS231-1040A-01M-R29-L14	14	43
S7847-1007	IS229-2024-80S-R29-L14	12	1
S7847-1008	IS229-2024-80S-R29-L14	12	1
S7960-1008	IS229-924-01S-R29-L14	12	1
S7961-1008	IS229-924-01S-R29-L14	12	1
S7986-01	IS229-924-01S-R29-L14	12	1
S7987-01	IS229-924-01S-R29-L14	12	1
S8377-256Q	IS229-308-01S-R29-L14	12	1
S8377-512Q	IS229-308-01S-R29-L14	12	1
S8378-256Q	IS229-308-01S-R29-L14	12	1
S8378-512Q	IS229-308-01S-R29-L14	12	1
S8379-1024Q	IS229-308-01S-R29-L14	12	1
S8380-256Q	IS229-422-01S-R29-L14	12	1
S8380-512Q	IS229-422-01S-R29-L14	12	1
S8381-256Q	IS229-422-01S-R29-L14	12	1
S8381-512Q	IS229-422-01S-R29-L14	12	1
S8380-128Q	IS229-422-01S-R29-L14	12	1
S8381-1024Q	IS229-422-01S-R29-L14	12	1
S8550	585-07-02-034-211M-R29-L14	23	31
S8658-01	IS231-1060-01M-R29-L14	Contact Factory	
S8665-0909	IS229-2024-80S-R29-L14	12	1
S8844-0909	IS229-924-01S-R29-L14	12	1
S9037-0902N	IS229-924-01S-R29-L14	12	1
S9037-1002	IS229-924-01S-R29-L14	12	1
S9037-1002N	IS229-924-01S-R29-L14	12	1
S9037-902	IS229-924-01S-R29-L14	12	1
S9038-0902	IS229-924-01S-R29-L14	12	1
S9038-0902N	IS229-924-01S-R29-L14	12	1
S9038-0902S	IS229-924-01S-R29-L14	12	1
S9038-1002	IS229-924-01S-R29-L14	12	1
S9038-1002N	IS229-924-01S-R29-L14	12	1
S9038-1002S	IS229-924-01S-R29-L14	12	1
S9226	IS229-308-01S-R29-L14	12	1
S9377-128Q	IS229-308-01S-R29-L14	12	1
S9736-01	IS229-924-01S-R29-L14	12	1
S9736-02	IS229-2024-80S-R29-L14	12	1
S9737-01	IS229-924-01S-R29-L14	12	1
S9737-02	IS229-2024-80S-R29-L14	12	1
S9840	IS229-322-01S-R29-L14	12	1
S9970-0906	IS229-424-01S-R29-L14	12	1
S9970-1006	IS229-424-80S-R29-L14	12	1
S9970-1007	IS229-424-80S-R29-L14	12	1
S9970-1008	IS229-624-01S-R29-L14	12	1
S9971-0906	IS229-624-01S-R29-L14	12	1
S9971-1006	IS229-624-01S-R29-L14	12	1
S9971-1007	IS229-624-01S-R29-L14	12	1
S9971-1008	IS229-924-01S-R29-L14	12	1
S9972-1007	IS229-424-01S-R29-L14	12	1
S9972-1008	IS229-624-01S-R29-L14	12	1
S9973-1007	IS229-624-01S-R29-L14	12	1
S9973-1008	IS229-924-01S-R29-L14	12	1

* Replace "X" with "0" for without index pin, or "1" for index pin

Hamamatsu continue http://www.hamamatsu.com			
Hamamatsu Part Number	Andon Part Number	Page	Fig.
S9978	IS229-924-01S-R29-L14	12	1
S9979	IS229-628-80S-R29-L14	12	1
Kilburn Isotronics			
Kilburn Isotronics Part Number	Andon Part Number	Page	Fig.
KTP-17001700-060-001	575-16-25-060-88M-R29-L14	17	32
Kodak / Truesense http://www.truesenseimaging.com			
Kodak Part Number	Andon Part Number	Page	Fig.
Dual Device Socket *	IS230D-97134-75M-R29-L14-A	20	41
Triple Device Socket *	IS230T-13205-75M-R29-L14-A	20	61
KAC-02000A	620-100-SM-G10-L14-X	25	23
KAC-6619M	680-48-SM-G10-R14-X	25	23
KAC-9618	680-48-SM-G10-R14-X	25	23
KAC-9619	680-48-SM-G10-R14-X	25	23
KAC-9628	680-48-SM-G10-R14-X	25	23
KAF-0261E	IS229-824-01S-R29-L14-A	13	1A
KAF-0402E	IS229-824-01S-R29-L14-A	13	1A
KAF-09000	IS229-2034-80S-R29-L14	12	1
KAF-1001E	IS229-1426-01S-R29-L14	12	1
KAF-10500	IS229-1060D-01M-R29-L14	14	3
KAF-1603	IS230-6367D-75M-R29-L14-A	19	38
KAF-16801E	IS229-2034-80S-R29-L14	12	1
KAF-16802CE	IS229-2034-80S-R29-L14	12	1
KAF-16803	IS229-2034-80S-R29-L14	12	1
KAF-18000	IS230-18860-75M-R29-L14	18	6
KAF-22000CE	IS229-2044-80M-R29-L14	12	1
KAF-31600	IS230-18860-75M-R29-L14	18	6
KAF-3200E	IS229-824-01S-R29-L14-A	13	1A
KAF-3200ME	IS229-824-01S-R29-L14-A	13	1A
KAF-39000	IS230-2064-75M-R29-L14	18	6
KAF-4202	IS229-1226-80S-R29-L14	12	1
KAF-4301E	405-20-01S-R29-L14 (QTY 2)	15	10
KAF-4320	Contact Factory		
KAF-50100	IS229-1752D-01M-R29-L14	13	39
KAF-6303E	IS229-8826-01S-R29-L14	12	1
KAF-8300	IS230-832-75S-R29-L14	18	6A
KAI-01050 LCC	680-64-SM-G10-R14-X	25	23
KAI-01050	IS230-6367D-75M-R29-L14-A	19	38
KAI-01150 LCC	680-64-SM-G10-R14-X	25	23
KAI-01150	IS230-6367D-75M-R29-L14-A	19	38
KAI-02050	680-64-SM-G10-R14-X	25	23
KAI-02050	IS230-6367D-75M-R29-L14-A	19	38
KAI-02150 LCC	680-64-SM-G10-R14-X	25	23
KAI-02150	IS230-6367D-75M-R29-L14-A	19	38
KAI-0330D	IS230-420-75S-R29-L14	18	6
KAI-0340D	IS232-522-274U-R27-L14	21	8
KAI-0373	IS229-824-01S-R29-L14-A	13	1A
KAI-04022	IS230-1034-75S-R29-L14-A	18	6A
KAI-04050	IS230-6367D-75M-R29-L14-A	19	38
KAI-08050	IS230-9767D-75M-R29-L14-A	19	40
KAI-1003M	IS229-1028-01S-R29-L14-A	13	1A
KAI-1010	IS229-824-01S-R29-L14-A	13	1A
KAI-10100	IS230-832-75S-R29-L14	18	6
KAI-1020 LCC	680-64-SM-G10-R14-X	25	23
KAI-1020 PGA	575-11-42-068-01M-R29-L14	16	15
KAI-11000	IS230-1340-75M-R29-L14	18	6
KAI-11000C	IS230-1340-75M-R29-L14	18	6

*accepts KAI-01050, KAI-02050, KAI-02150, KAI-29050, KAI-04050, KAI-08050, or KAF-1603

For Other Pin Configuration or Layouts, Contact Factory.

RoHS Compliant

Andon Proprietary Information

IS-13A 03/15/13

Image Sensor to Socket Cross Reference

[Back to Table of Contents](#)

Kodak / Truesense <i>continue</i> http://www.truesenseimaging.com			
Kodak Part Number	Andon Part Number	Page	Fig.
KAI-11000CM	IS230-1340-75M-R29-L14	18	6
KAI-11002	IS230-1340-75M-R29-L14	18	6
KAI-1600	IS230-1340-75M-R29-L14	18	6
KAI-16000	IS230-1340-75M-R29-L14	18	6
KAI-16050	IS230-1371D-75M-R29-L14-A	19	54
KAI-16070	IS230-1371D-75M-R29-L14-A	19	54
KAI-1800	IS230-18860-75M-R29-L14	18	6
KAI-2001	IS230-832-75S-R29-L14-A	18	6A
KAI-2020	IS230-832-75S-R29-L14-A	18	6A
KAI-2093M	IS230-832-75S-R29-L14-A	18	6A
KAI-29050	IS230-1371D-75M-R29-L14-A	19	54
KAI-31600	IS230-18860-75M-R29-L14	18	6
KAI-4010M	IS230-1034-75S-R29-L14-A	18	6A
KAI-4011	IS230-1034-75S-R29-L14-A	18	6A
KAI-4021	IS230-1034-75S-R29-L14-A	18	6A
KAI-4021CM	IS230-1034-75S-R29-L14-A	18	6A
KAI-4021M	IS230-1034-75S-R29-L14-A	18	6A
KLI-10203	IS231-6140-01M-R29-L14	13	7
KLI-14403	IS231-6140-01M-R29-L14	13	7
KLI-2113	IS229-6128-01S-R29-L14	12	1
KLI-4104	IS233-4146-75M-R29-L14	19	9
KLI-5001	IS229-6124-01S-R29-L14	12	1
KLI-8023	IS231-6140-01M-R29-L14	13	7

Kyocera http://global.kyocera.com			
Kyocera Part Number	Andon Part Number	Page	Fig.
KD-DA6014-A	620-84-SM-G10-L14-X	25	23
KD-S88423-B	IS229-640-01M-R29-S12	12	1
PB-C86131	620-84-SM-G10-L14-1	25	23
PB-C97222	620-20-SM-G10-L14-0	25	23
PB-F86315	Contact Factory		
PB-12832-B	620-44-SM-G10-L14-X	25	23
PB-13046-A	620-28-SM-G10-L14-0	25	23

Motorola http://www.motorola.com/us			
Motorola Part Number	Andon Part Number	Page	Fig.
MCM 20014	680-48-SM-G10-R14-X	25	23
MCM 20027	680-48-SM-G10-R14-X	25	23

National Semiconductor			
National Semiconductor Part Number	Andon Part Number	Page	Fig.
LM9617CCEA	680-48-SM-G10-R14-X	25	23
LM9617CCEA-2	680-48-SM-G10-R14-X	25	23
LM9627CCEA	680-48-SM-G10-R14-X	25	23
LM9627CCEA-2	680-48-SM-G10-R14-X	25	23
LM9648CEA	680-48-SM-G10-R14-X	25	23

NEC http://www.nec.com			
NEC Part Number	Andon Part Number	Page	Fig.
μPD3728DZ	IS231-636-01S-R29-L14	13	7
μPD3734A	IS229-422-80S-R29-L14	12	1
μPD3737	IS229-422-80S-R29-L14	12	1
μPD3739	IS229-422-80S-R29-L14	12	1
μPD3747	IS229-422-80S-R29-L14	12	1
μPD3753	IS229-422-80S-R29-L14	12	1
μPD3768	IS231-636-01S-R29-L14	13	7
μPD3778	IS229-432-80S-R29-L14	12	1
μPD3788	IS231-636-01S-R29-L14	13	7
μPD3798	IS229-432-80S-R29-L14	12	1
μPD3799	IS229-432-80S-R29-L14	12	1
μPD8861	IS229-422-80S-R29-L14	12	1
μpd8870	IS229-432-80S-R29-L14	12	1
μpd8870	IS229-432-80S-R29-L14	12	1

* Replace "X" with "0" for without index pin, or "1" for index pin

ON Semiconductor / Cypress http://www.cypress.com			
See Cypress, Page 6			

OSI Optoelectronics http://www.osioptoelectronics.com			
OSI Optoelectronics Part Number	Andon Part Number	Page	Fig.
UDT-4X4D	680-40-SM-G10-L14-X	25	23

Panavision www.panavisionimaging.com			
Panavision Part Number	Andon Part Number	Page	Fig.
ELIS-1024-D-ES	IS229-316-01S-R29-L14	12	1

Peripheral			
Peripheral Part Number	Andon Part Number	Page	Fig.
PI0128WSN	IS229-422-01S-R29-L14	12	1
PI0256HSN	IS229-422-01S-R29-L14	12	1
PI0256WSN	IS229-422-01S-R29-L14	12	1
PI0512HSN	IS229-422-01S-R29-L14	12	1
PI0512WS	IS229-422-01S-R29-L14	12	1
PI0512WSN	IS229-422-01S-R29-L14	12	1
PI1024HSN	IS229-422-01S-R29-L14	12	1

Perkin Elmer http://www.perkinelmer.com			
Perkin Elmer Part Number	Andon Part Number	Page	Fig.
HL2048P	IS229-420-01S-R29-L14	12	1
HL4096P	IS231-428-01S-R29-L14	13	7
RA1133J	IS229-1330-01M-R29-L14	12	1
RL0512P	IS229-420-01S-R29-L14	12	1
RL1024P	IS229-420-01S-R29-L14	12	1
RL1201	IS229-422-01S-R29-L14	12	1
RL1202	IS229-422-01S-R29-L14	12	1
RL1205	IS229-422-01S-R29-L14	12	1
RL1205	IS229-422-01S-R29-L14	12	1
RL1501	IS229-422-01S-R29-L14	12	1
RL1502	IS229-422-01S-R29-L14	12	1
RL1505	IS229-422-01S-R29-L14	12	1
RL2048P	IS229-420-01S-R29-L14	12	1
PT1109AAQ	IS229-432-80S-R29-L14	12	1

Philips			
Philips Part Number	Andon Part Number	Page	Fig.
FT 18	IS230-632-75S-R29-L14	18	6
FTF3020-C	575-20-16-096-01M-R29-L14	16	22
FTF3020-M	575-20-16-096-01M-R29-L14	16	22
FTT1010-M	575-15-63-080-01M-R29-L14	16	20
SA5212A	IS229-308-01S-R29-L14	12	1
SAA4981	IS229-624-01S-R29-L14	12	1
SCC2691	IS229-324-01S-R29-L14	12	1

Samsung			
Samsung Part Number	Andon Part Number	Page	Fig.
S5f329PW02	IS230-416-75S-R29-L14	18	6

SiTe http://www.SiTe.com			
SiTe Part Number	Andon Part Number	Page	Fig.
SI-003A	575-15-64-056-88M-R29-L14	16	21
SI-502A	575-12-22-044-88M-R29-L14	16	17

Sony			
Sony Part Number	Andon Part Number	Page	Fig.
ICS429ALB	IS232-316-274U-R27-L14	21	8
ICX038DNA	IS230-620-75S-R29-L14	18	6
ICX098BL	IS232-414-274U-R27-L14	21	8
ICX098BQ	IS232-414-274U-R27-L14	21	8
ICX204AK	IS232-4516-274U-R27-L14	21	8
ICX204AL	IS232-4516-274U-R27-L14	21	8

For Other Pin Configuration or Layouts, Contact Factory.

RoHS Compliant

Andon Proprietary Information

IS-13A 03/15/13

©Copyright 2013 Andon Electronics Corporation. All Rights Reserved. This material is protected under US and other copyrights and may not be copied, sold, or redistributed in any form without written permission of Andon Electronics Corporation. Copyrights and trademarks are property of their respective companies. We reserve the right to change specifications without notice. Andon makes no warranty, expressed or implied, as to the suitability of the sockets for the intended purpose.

Image Sensor to Socket Cross Reference

[Back to Table of Contents](#)

Sony continue			
Sony Part Number	Andon Part Number	Page	Fig.
ICX205AK	IS230-620-75S-R29-L14	18	6
ICX205AL	IS230-620-75S-R29-L14	18	6
ICX206AK	IS232-414-274U-R27-L14	21	8
ICX206AKB	R225-1413-01N-400T4-R27-L14	23	34
ICX206AL	IS232-414-274U-R27-L14	21	8
ICX207AK	IS232-414-274U-R27-L14	21	8
ICX207AKB	R225-1413-01N-400T4-R27-L14	23	34
ICX207AL	IS232-414-274U-R27-L14	21	8
ICX224AK	IS232-520-274U-R27-L14	21	8
ICX224AQ	IS232-4820-274U-R27-L14	21	8
ICX226AK	IS232-414-274U-R27-L14	21	8
ICX226AL	IS232-414-274U-R27-L14	21	8
ICX227AK	IS232-414-274U-R27-L14	21	8
ICX227AL	IS232-414-274U-R27-L14	21	8
ICX228AK	IS232-414-274U-R27-L14	21	8
ICX228AL	IS232-414-274U-R27-L14	21	8
ICX229AK	IS232-414-274U-R27-L14	21	8
ICX229AL	IS232-414-274U-R27-L14	21	8
ICX232BQ	IS232-416-274U-R27-L14	21	8
ICX252AK	IS232-4820-274U-R27-L14	21	8
ICX252AQ	IS232-4820-274U-R27-L14	21	8
ICX254AK	IS232-4516-274U-R27-L14	21	8
ICX254AL	IS232-4516-274U-R27-L14	21	8
ICX255AK	IS232-4516-274U-R27-L14	21	8
ICX255AL	IS232-4516-274U-R27-L14	21	8
ICX258AK	IS232-4516-274U-R27-L14	21	8
ICX258AL	IS232-4516-274U-R27-L14	21	8
ICX259AK	IS232-4516-274U-R27-L14	21	8
ICX259AL	IS232-4516-274U-R27-L14	21	8
ICX262AQ	IS232-4820-274U-R27-L14	21	8
ICX267AK	IS232-4820-274U-R27-L14	21	8
ICX274AL	IS232-4820-274U-R27-L14	21	8
ICX278AK	IS232-414-274U-R27-L14	21	8
ICX278AL	IS232-414-274U-R27-L14	21	8
ICX279AK	IS232-414-274U-R27-L14	21	8
ICX282AK	IS232-5724-274U-R27-L14	21	8
ICX282AQ	IS232-5724-274U-R27-L14	21	8
ICX284AK	IS232-4516-274U-R27-L14	21	8
ICX284AQ	IS232-4516-274U-R27-L14	21	8
ICX285AL	IS229-820-80S-R29-L14	12	1
ICX285AQ	IS229-820-80S-R29-L14	12	1
ICX404AK	IS232-4516-274U-R27-L14	21	8
ICX404AL	IS232-4516-274U-R27-L14	21	8
ICX405AK	IS232-4516-274U-R27-L14	21	8
ICX405AL	IS232-4516-274U-R27-L14	21	8
ICX406AQ	IS232-4820-274U-R27-L14	21	8
ICX408AK	IS232-4516-274U-R27-L14	21	8
ICX408AL	IS232-4516-274U-R27-L14	21	8
ICX409AK	IS232-4516-274U-R27-L14	21	8
ICX409AL	IS232-4516-274U-R27-L14	21	8
ICX412AQ	IS232-4820-274U-R27-L14	21	8
ICX414-AL	IS232-622-274U-R27-L14	21	8
ICX414AQ	IS232-622-274U-R27-L14	21	8
ICX415AL	IS232-622-274U-R27-L14	21	8
ICX415AQ	IS232-622-274U-R27-L14	21	8
ICX418AKB	IS232-316-274U-R27-L14	21	8
ICX418AKL	IS230-620-75S-R29-L14	18	6
ICX418ALL	IS230-620-75S-R29-L14	18	6
ICX419AKB	IS232-316-274U-R27-L14	21	8

Sony continue			
Sony Part Number	Andon Part Number	Page	Fig.
ICX419AKL	IS230-620-75S-R29-L14	18	6
ICX419ALB	IS232-316-274U-R27-L14	21	8
ICX419ALL	IS230-620-75S-R29-L14	18	6
ICX422AL	IS229-820-80S-R29-L14	12	1
ICX423AL	IS229-820-80S-R29-L14	12	1
ICX424AL	IS232-4516-274U-R27-L14	21	8
ICX424AQ	IS232-4516-274U-R27-L14	21	8
ICX428AKL	IS230-620-75S-R29-L14	18	6
ICX428ALB	IS232-316-274U-R27-L14	21	8
ICX428ALL	IS230-620-75S-R29-L14	18	6
ICX429AKL	IS230-620-75S-R29-L14	18	6
ICX429ALL	IS230-620-75S-R29-L14-A	18	6A
ICX432DQ	IS0437SP-418-C4-G10-L14	23	45
ICX434AQ	IS232-4516-274U-R27-L14	21	8
ICX445ALA	IS232-5724-274U-R27-L14	21	8
ICX614AKA	IS232-414-274U-R27-L14	21	8
ICX618ALA	IS232-414-274U-R27-L14	21	8
ICX625ALA	IS0437SP-5728-C4-G10-L14	23	44
ICX655	419-14-C4-G10-L14	23	69
ICX655ALA	IS0437SP-5728-C4-G10-L14	23	44
ICX674	IS230D-6968SP-443M-R29-L14-A	18	67
ILX551A	IS229-422-80S-R29-L14	12	1
ILX551B	IS229-422-80S-R29-L14	12	1
ILX553A	IS229-422-80S-R29-L14	12	1
ILX553B	IS229-422-80S-R29-L14	12	1
ILX554B	IS229-422-80S-R29-L14	12	1
ILX555K	IS229-422-80S-R29-L14	12	1
ILX558K	IS229-422-80S-R29-L14	12	1
ILX569K	IS229-422-80S-R29-L14	12	1
ILX585K	IS233-424-75S-R29-L14	19	9
ILX751A	IS229-422-80S-R29-L14	12	1
ILX751B	IS229-422-80S-R29-L14	12	1
ISX205AK	IS230-620-75S-R29-L14	18	6

Teledyne / Dalsa <http://www.teledynedalsa.com>

See Dalsa, Page 6

Texas Instruments <http://www.ti.com>

TI Part Number	Andon Part Number	Page	Fig.
TC211	IS229-306-01S-R29-L14	12	1
TC217	IS229-422-88S-R29-L14-A	13	1A
TC237B	IS230-4512-75S-R29-L14	18	6
TC241	IS229-422-88S-R29-L14-A	13	1A
TC246	IS230-724-75S-R29-L14-A	18	6A
TC247	IS230-724-75S-R29-L14-A	18	6A
TC253	IS230-4512-75S-R29-L14	18	6
TC255	IS229-408-01S-R29-L14	12	1
TC281	IS229-722-80S-R29-L14-A	13	1A
TC285SPD-31	IS230-828-75S-R29-L14	18	6
TC341	IS229-722-80S-R29-L14-A	13	1A

Toshiba

Toshiba Part Number	Andon Part Number	Page	Fig.
TCD1201D	IS229-422-01S-R29-L14	12	1
TCD1205D	IS229-422-01S-R29-L14	12	1
TCD1304AP	IS229-422-80S-R29-L14	12	1
TCD1500C	IS229-422-01S-R29-L14	12	1
TCD1501C	IS229-422-01S-R29-L14	12	1
TCD1502C	IS229-422-01S-R29-L14	12	1
TCD1702C	IS229-422-01S-R29-L14	12	1
TCD1707D	IS229-422-01S-R29-L14	12	1

For Other Pin Configuration or Layouts, Contact Factory.

RoHS Compliant

Andon Proprietary Information

IS-13A 03/15/13

.100 [2.54] Pitch Image Sensor DIP Sockets

[Back to Table of Contents](#)

Top View Shown
Units: in [mm]

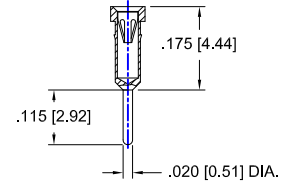
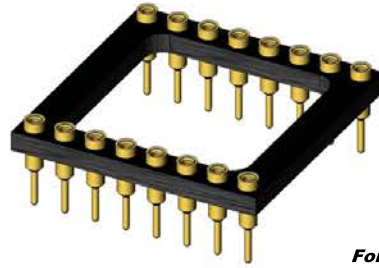
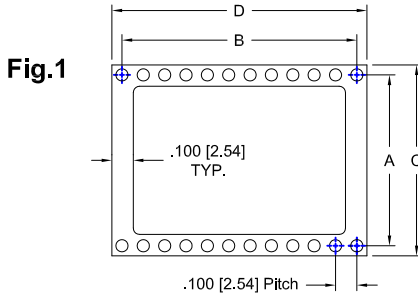

- 01 Terminal Shown

For Terminal Details or other Terminal Types see Page 26

.100 [2.54] Pitch

Andon Part Number w/Thru-Hole Terminal	Surface Mount Terminal	Figure Number	Pin QTY.	A	B	C	D
IS229-306-01S-R29-L14	93S	1	6	.300 (7.62)	.200 (5.08)	.397 (10.08)	.297 (7.54)
IS229-308-01S-R29-L14	93S	1	8	.300 (7.62)	.300 (7.62)	.397 (10.08)	.397 (10.08)
IS229-316-01S-R29-L14	93S	1	16	.300 (7.62)	.700 (17.78)	.397 (10.08)	.797 (20.24)
IS229-318-01S-R29-L14	93S	1	18	.300 (7.62)	.800 (20.32)	.397 (10.08)	.897 (22.78)
IS229-324-01S-R29-L14	93S	1	24	.300 (7.62)	1.100 (27.94)	.397 (10.08)	1.197 (30.40)
IS229-39524-01S-R29-L14	93S	1	24	.395 (10.03)	1.100 (27.94)	.492 (12.50)	1.197 (30.40)
IS229-408-01S-R29-L14	93S	1	8	.400 (10.16)	.300 (7.62)	.497 (12.62)	.397 (10.08)
IS229-420-01S-R29-L14	93S	1	20	.400 (10.16)	.900 (22.86)	.497 (12.62)	.997 (25.32)
IS229-422-01S-R29-L14	93S	1	22	.400 (10.16)	1.000 (25.40)	.497 (12.62)	1.097 (27.86)
IS229-424-01S-R29-L14	93S	1	24	.400 (10.16)	1.100 (27.94)	.497 (12.62)	1.197 (30.40)
IS229-424-400T4-R29-L14	93S	1	24	.400 (10.16)	1.100 (27.94)	.497 (12.62)	1.197 (30.40)
IS229-432-80S-R29-L14	93S	1	32	.400 (10.16)	1.500 (38.10)	.497 (12.62)	1.597 (40.56)
IS229-620-01S-R29-L14	93S	1	20	.600 (15.24)	.900 (22.86)	.697 (17.70)	.997 (25.32)
IS229-622-01S-R29-L14	93S	1	22	.600 (15.24)	1.000 (25.40)	.697 (17.70)	1.097 (27.86)
IS229-624-01S-R29-L14	93S	1	24	.600 (15.24)	1.100 (27.94)	.697 (17.70)	1.197 (30.40)
IS229-624-80S-R29-L14	93S	1	24	.600 (15.24)	1.100 (27.94)	.697 (17.70)	1.197 (30.40)
IS229-628-80S-R29-L14	93S	1	28	.600 (15.24)	1.300 (33.02)	.697 (17.70)	1.397 (35.48)
IS229-640-01M-R29-L14	93S	1	40	.600 (15.24)	1.900 (48.26)	.697 (17.70)	1.997 (50.72)
IS229-648-01M-R29-L14	93M	1	48	.600 (15.24)	2.300 (58.42)	.697 (17.70)	2.397 (60.88)
IS229-650-01M-R29-L14	93M	1	50	.600 (15.24)	2.400 (60.96)	.697 (17.70)	2.497 (63.42)
IS229-656-01M-R29-L14	93M	1	56	.600 (15.24)	2.700 (68.58)	.697 (17.70)	2.797 (71.04)
IS229-6120-80S-R29-L14	93S	1	20	.610 (15.49)	.900 (22.86)	.707 (17.96)	.997 (25.32)
IS229-6124-01S-R29-L14	93S	1	24	.610 (15.49)	1.100 (27.94)	.707 (17.96)	1.197 (30.40)
IS229-6128-01S-R29-L14	93S	1	28	.610 (15.49)	1.300 (33.02)	.707 (17.96)	1.397 (35.48)
IS229-6140-01M-R29-L14	93M	1	40	.610 (15.49)	1.900 (48.26)	.707 (17.96)	1.997 (50.72)
IS229-820-80S-R29-L14	93S	1	20	.800 (20.32)	.900 (22.86)	.897 (22.78)	.997 (25.32)
IS229-824-01S-R29-L14	93S	1	24	.800 (20.32)	1.100 (27.94)	.897 (22.78)	1.197 (30.40)
IS229-826-01S-R29-L14	93S	1	26	.800 (20.32)	1.200 (30.48)	.897 (22.78)	1.297 (32.94)
IS229-828-88S-R29-L14	93S	1	28	.800 (20.32)	1.300 (33.02)	.897 (22.78)	1.397 (35.48)
IS229-8824-01S-R29-L14	93S	1	24	.880 (22.35)	1.100 (27.94)	.977 (24.82)	1.970 (50.04)
IS229-8826-01S-R29-L14	93S	1	26	.880 (22.35)	1.200 (30.48)	.977 (24.82)	1.297 (32.94)
IS229-8826-80S-R29-L14	93S	1	26	.880 (22.35)	1.200 (30.48)	.977 (24.82)	1.297 (32.94)
IS229-924-01S-R29-L14	93S	1	24	.900 (22.86)	1.100 (27.94)	.997 (25.32)	1.197 (30.40)
IS229-932-01S-R29-L14	93S	1	32	.900 (22.86)	1.500 (38.10)	.997 (25.32)	1.597 (40.56)
IS229-938-01S-R29-L14	93S	1	38	.900 (22.86)	1.800 (45.72)	.997 (25.32)	1.897 (48.18)
IS229-940-01M-R29-L14	93M	1	40	.900 (22.86)	1.900 (48.26)	.997 (25.32)	1.997 (50.72)
IS229-944-01M-R29-L14	93M	1	44	.900 (22.86)	2.100 (53.34)	.997 (25.32)	2.197 (55.80)
IS229-9124-80S-R29-L14	93S	1	24	.910 (23.11)	1.100 (27.94)	1.007 (25.58)	1.197 (30.40)
IS229-1226-80S-R29-L14	93S	1	26	1.200 (30.48)	1.200 (30.48)	1.297 (32.94)	1.297 (32.94)
IS229-1330-01M-R29-L14	93M	1	30	1.300 (33.02)	1.400 (35.56)	1.397 (35.48)	1.497 (38.02)
IS229-1426-01S-R29-L14	93S	1	26	1.410 (35.81)	1.200 (30.48)	1.507 (38.28)	1.297 (32.94)
IS229-1824-80S-R29-L14	93S	1	24	1.800 (45.72)	1.100 (27.94)	1.897 (48.18)	1.197 (30.40)
IS229-2024-80S-R29-L14	93S	1	24	2.000 (50.80)	1.100 (27.94)	2.097 (53.26)	1.197 (30.40)
IS229-2034-80S-R29-L14	93S	1	34	2.010 (51.05)	1.600 (40.64)	2.107 (53.52)	1.697 (43.10)
IS229-2044-80M-R29-L14	93M	1	44	2.010 (51.05)	2.100 (53.34)	2.107 (53.52)	2.197 (55.80)
IS229-2640-01M-R29-L14	93M	1	40	2.600 (66.04)	1.900 (48.26)	2.697 (68.50)	1.997 (50.72)
IS229-2640-01M-R29-L14-SIP	93M	1	40	2.600 (66.04)	1.900 (48.26)	2.697 (68.50)	1.997 (50.72)
IS229-2654-01M-R29-L14-SIP	93M	1	54	2.600 (66.04)	2.600 (66.04)	2.697 (68.50)	2.697 (68.50)

For Other Pin Configuration or Layouts, Contact Factory.

.100 [2.54] Pitch Image Sensor DIP Sockets

[Back to Table of Contents](#)

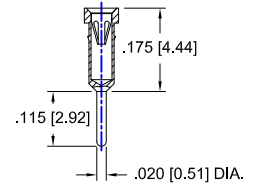
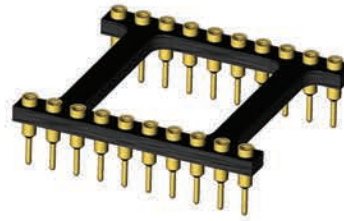
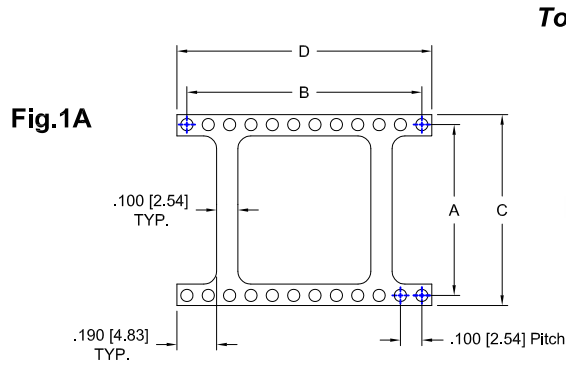

- 01 Terminal Shown

For Terminal Details or other Terminal Types see Page 26

.100 [2.54] Pitch

Andon Part Number w/Thru-hole Terminal	Surface Mount Terminal	Figure Number	Pin QTY.	A	B	C	D
IS229-422-88S-R29-L14-A	93S	1A	22	.400 (10.16)	1.000 (25.40)	.497 (12.62)	1.097 (27.86)
IS229-722-80S-R29-L14-A	93S	1A	22	.700 (17.78)	1.000 (25.40)	.797 (20.24)	1.097 (27.86)
IS229-820-80S-R29-L14-A	93S	1A	20	.800 (20.32)	.900 (22.86)	.897 (22.78)	.997 (25.32)
IS229-824-01S-R29-L14-A	93S	1A	24	.800 (20.32)	1.100 (27.94)	.897 (22.78)	1.197 (30.40)
IS229-1028-01S-R29-L14-A	93S	1A	28	1.005 (25.53)	1.300 (33.02)	1.102 (27.99)	1.397 (35.48)

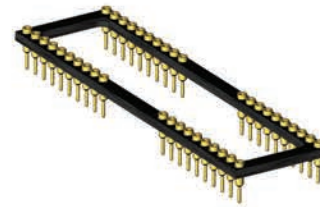
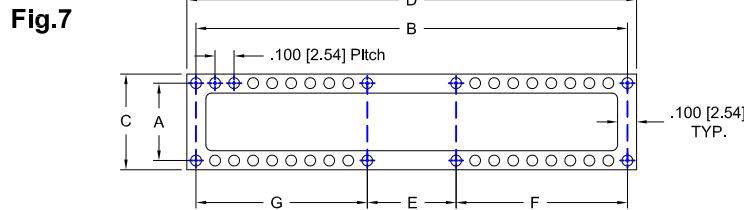

Andon Part Number w/Thru-hole Terminal	SMT #	FIG #	Pin QTY	A	B	C	D	E	F	G
IS231-428-01S-R29-L14	93S	7	28	.400 (10.16)	2.500 (63.50)	.497 (12.62)	2.597 (65.96)	1.300 (33.02)	.600 (15.24)	.600 (15.24)
IS231-622-01S-R29-L14	93S	7	22	.600 (15.24)	1.900 (48.26)	.697 (17.70)	1.997 (50.72)	1.000 (25.40)	.500 (12.70)	.400 (10.16)
IS231-636-01S-R29-L14	93S	7	36	.600 (15.24)	3.500 (88.90)	.697 (17.70)	3.597 (91.36)	1.900 (48.26)	.800 (20.32)	.800 (20.32)
IS231-644-80M-R29-L14	93M	7	44	.600 (15.24)	3.500 (88.90)	.697 (17.70)	3.597 (91.36)	1.500 (38.10)	1.000 (25.40)	1.000 (25.40)
IS231-6140-01M-R29-L14	93M	7	40	.610 (15.49)	2.500 (63.50)	.707 (17.96)	2.597 (65.96)	.700 (17.78)	.900 (22.86)	.900 (22.86)

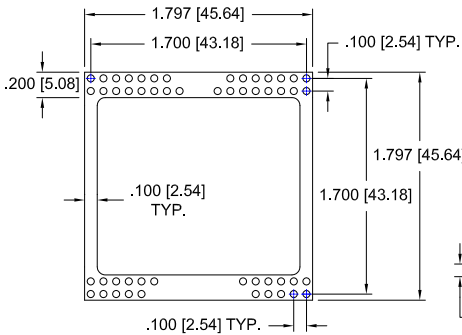

Fig.39
52 Pins
Thru-Hole: IS229-1752D-01M-R29-L14
Surface Mount: IS229-1752D-93M-R29-L14

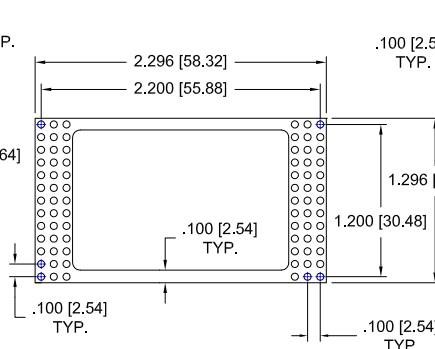

Fig.42
78 Pins
Thru-Hole: IS229-2278T-01M-R29-L14
Surface Mount: IS229-2278T-93M-R29-L14

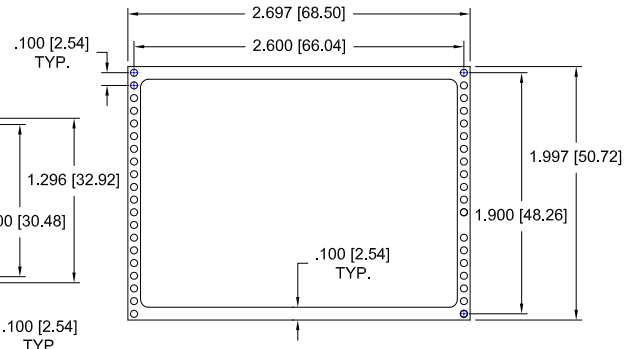

Fig.61
96 Pins
Thru-Hole: IS229-2639-01M-R29-L14
Surface Mount: IS229-2639-93M-R29-L14

For Other Pin Configuration or Layouts, Contact Factory.

RoHS Compliant
Andon Proprietary Information
IS-13A 03/15/13

©Copyright 2013 Andon Electronics Corporation. All Rights Reserved. This material is protected under US and other copyrights and may not be copied, sold, or redistributed in any form without written permission of Andon Electronics Corporation. Copyrights and trademarks are property of their respective companies. We reserve the right to change specifications without notice. Andon makes no warranty, expressed or implied, as to the suitability of the sockets for the intended purpose.

.100 [2.54] Pitch Image Sensor DIP Sockets

[Back to Table of Contents](#)

-100 [2.54] Pitch

Top View Shown
Units: in [mm]

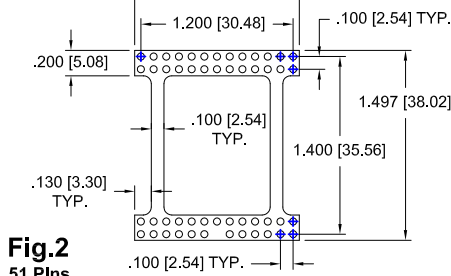

Fig.2
51 Pins

Thru-Hole: IS229-1451D-80M-R29-L14-A
Surface Mount: IS229-1451D-93M-R29-L14-A

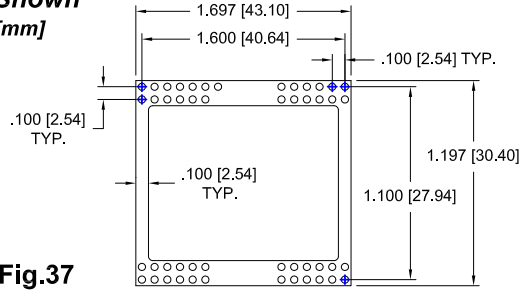
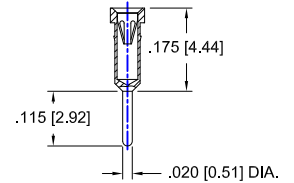
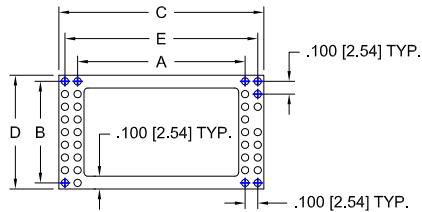

Fig.37
49 Pins

Thru-Hole: IS231-1149D-01M-R29-L14
Surface Mount: IS231-1149D-93M-R29-L14

Fig.3



For Terminal Details or other
Terminal Types see Page 26

- 01 Terminal Shown

Andon Part Number w/Thru-hole Terminal	Surface Mount Terminal	Figure Number	Pin QTY.	A	B	C	D	E
IS229-780D-01M-R29-L14	93M	3	80	.500 (12.70)	1.900 (48.26)	.796 (20.22)	1.996 (50.70)	.700 (17.78)
IS229-1060D-01M-R29-L14	93M	3	60	.850 (21.59)	1.400 (29.11)	1.146 (29.10)	1.496 (37.99)	1.050 (26.67)
IS229-1536D-01S-R29-L14	93S	3	36	1.320 (33.53)	.800 (20.32)	1.616 (41.05)	.896 (22.76)	1.520 (38.61)
IS229-1639D-80S-R29-L14	93S	3	39	1.400 (35.56)	.900 (22.86)	1.696 (43.08)	.996 (25.30)	1.600 (40.64)
IS229-1644D-01M-R29-L14	93M	3	44	1.400 (35.56)	1.000 (25.40)	1.696 (43.08)	1.096 (27.84)	1.600 (40.64)
IS229-1944D-01M-R29-L14	93M	3	44	1.700 (43.18)	1.000 (25.40)	1.996 (50.70)	1.096 (27.84)	1.900 (48.26)
IS229-2488D-01M-R29-L14	93M	3	88	2.200 (55.88)	2.100 (53.34)	2.496 (63.39)	2.197 (55.80)	2.400 (62.99)
IS229-3080D-01M-R29-L14	93M	3	80	2.800 (71.12)	1.900 (48.26)	3.096 (78.64)	1.997 (50.72)	3.000 (76.20)

Fig.11

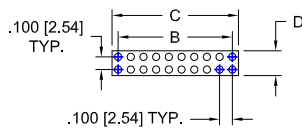

Andon Part Number w/Thru-hole Terminal	Surface Mount Terminal	Figure Number	Pin QTY.	B	C	D
409-209-01S-R29-L14	93S	11	18	.800 (20.32)	.897 (22.78)	.196 (4.98)
409-210-80S-R29-L14	93S	11	20	.900 (22.86)	.900 (22.86)	.196 (4.98)
409-211-01S-R29-L14	93S	11	22	1.000 (25.40)	1.000 (25.40)	.196 (4.98)
409-213-80S-R29-L14	93S	11	26	1.200 (30.48)	1.200 (30.48)	.196 (4.98)

Fig.43
40 Pins

Thru-Hole: IS231-1040A-01M-R29-L14
Surface Mount: IS231-1040A-93M-R29-L14

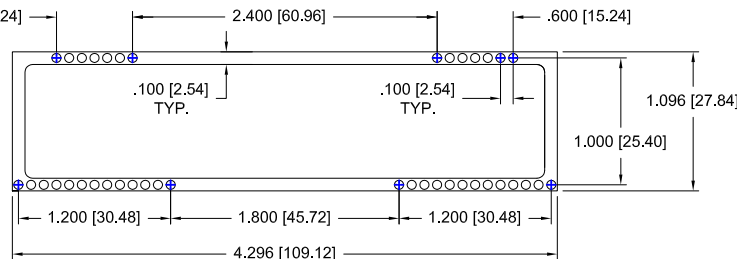

For Other Pin Configuration or Layouts, Contact Factory.

RoHS Compliant

Andon Proprietary Information

IS-13A 03/15/13

©Copyright 2013 Andon Electronics Corporation. All Rights Reserved. This material is protected under US and other copyrights and may not be copied, sold, or redistributed in any form without written permission of Andon Electronics Corporation. Copyrights and trademarks are property of their respective companies. We reserve the right to change specifications without notice. Andon makes no warranty, expressed or implied, as to the suitability of the sockets for the intended purpose.

.100 [2.54] Pitch Image Sensor SIP Sockets

[Back to Table of Contents](#)

Top View Shown
Units: in [mm]

Fig.10

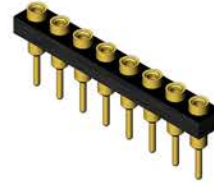
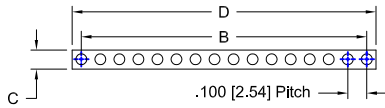

.100 [2.54] Pitch

Andon Part # w/Thru-Hole Terminal	Surface Mount Terminal	Figure #	Pin QTY.	B	C	D	Andon Part # w/Thru-Hole Terminal	Surface Mount Terminal	Figure #	Pin QTY.	B	C	D
405-03-01S-R29-L14	93S	10	3	.200 (5.08)	.100 (2.54)	.297 (7.54)	405-16-80S-R29-L14	93S	10	16	1.500 (38.10)	.100 (2.54)	1.597 (40.56)
405-03-80S-R29-L14	93S	10	3	.200 (5.08)	.100 (2.54)	.297 (7.54)	405-17-01S-R29-L14	93S	10	17	1.600 (40.64)	.100 (2.54)	1.697 (43.10)
405-04-01S-R29-L14	93S	10	4	.300 (7.62)	.100 (2.54)	.397 (10.08)	405-17-80S-R29-L14	93S	10	17	1.600 (40.64)	.100 (2.54)	1.697 (43.10)
405-04-80S-R29-L14	93S	10	4	.300 (7.62)	.100 (2.54)	.397 (10.08)	405-18-01S-R29-L14	93S	10	18	1.700 (43.18)	.100 (2.54)	1.797 (45.64)
405-05-01S-R29-L14	93S	10	5	.400 (10.16)	.100 (2.54)	.497 (12.62)	405-18-80S-R29-L14	93S	10	18	1.700 (43.18)	.100 (2.54)	1.797 (45.64)
405-05-80S-R29-L14	93S	10	5	.400 (10.16)	.100 (2.54)	.497 (12.62)	405-19-01S-R29-L14	93S	10	19	1.800 (45.72)	.100 (2.54)	1.897 (48.18)
405-06-01S-R29-L14	93S	10	6	.500 (12.70)	.100 (2.54)	.597 (15.16)	405-19-80S-R29-L14	93S	10	19	1.800 (45.72)	.100 (2.54)	1.897 (48.18)
405-06-80S-R29-L14	93S	10	6	.500 (12.70)	.100 (2.54)	.597 (15.16)	405-20-01S-R29-L14	93S	10	20	1.900 (48.26)	.100 (2.54)	1.997 (50.72)
405-07-01S-R29-L14	93S	10	7	.600 (15.24)	.100 (2.54)	.697 (17.70)	405-20-80S-R29-L14	93S	10	20	1.900 (48.26)	.100 (2.54)	1.997 (50.72)
405-07-80S-R29-L14	93S	10	7	.600 (15.24)	.100 (2.54)	.697 (17.70)	405-21-01S-R29-L14	93S	10	21	2.000 (50.80)	.100 (2.54)	2.097 (53.26)
405-08-01S-R29-L14	93S	10	8	.700 (17.78)	.100 (2.54)	.797 (20.24)	405-21-80S-R29-L14	93S	10	21	2.000 (50.80)	.100 (2.54)	2.097 (53.26)
405-08-80S-R29-L14	93S	10	8	.700 (17.78)	.100 (2.54)	.797 (20.24)	405-22-01S-R29-L14	93S	10	22	2.100 (53.34)	.100 (2.54)	2.197 (55.80)
405-09-01S-R29-L14	93S	10	9	.800 (20.32)	.100 (2.54)	.897 (22.78)	405-22-80S-R29-L14	93S	10	22	2.100 (53.34)	.100 (2.54)	2.197 (55.80)
405-09-80S-R29-L14	93S	10	9	.800 (20.32)	.100 (2.54)	.897 (22.78)	405-23-01S-R29-L14	93S	10	23	2.200 (55.88)	.100 (2.54)	2.297 (58.34)
405-10-01S-R29-L14	93S	10	10	.900 (22.86)	.100 (2.54)	.997 (25.32)	405-23-80S-R29-L14	93S	10	23	2.200 (55.88)	.100 (2.54)	2.297 (58.34)
405-10-80S-R29-L14	93S	10	10	.900 (22.86)	.100 (2.54)	.997 (25.32)	405-24-01S-R29-L14	93S	10	24	2.300 (58.42)	.100 (2.54)	2.397 (60.88)
405-11-01S-R29-L14	93S	10	11	1.000 (25.40)	.100 (2.54)	1.097 (27.86)	405-24-80S-R29-L14	93S	10	24	2.300 (58.42)	.100 (2.54)	2.397 (60.88)
405-11-80S-R29-L14	93S	10	11	1.000 (25.40)	.100 (2.54)	1.097 (27.86)	405-25-01S-R29-L14	93S	10	25	2.400 (60.96)	.100 (2.54)	2.497 (63.42)
405-11-88S-R29-L14	93S	10	11	1.000 (25.40)	.100 (2.54)	1.097 (27.86)	405-25-80S-R29-L14	93S	10	25	2.400 (60.96)	.100 (2.54)	2.497 (63.42)
405-12-01S-R29-L14	93S	10	12	1.100 (27.94)	.100 (2.54)	1.197 (30.40)	405-26-01S-R29-L14	93S	10	26	2.500 (63.50)	.100 (2.54)	2.597 (65.96)
405-12-80S-R29-L14	93S	10	12	1.100 (27.94)	.100 (2.54)	1.197 (30.40)	405-26-80S-R29-L14	93S	10	26	2.500 (63.50)	.100 (2.54)	2.597 (65.96)
405-13-01S-R29-L14	93S	10	13	1.200 (30.48)	.100 (2.54)	1.297 (32.94)	405-27-01S-R29-L14	93S	10	27	2.600 (66.04)	.100 (2.54)	2.697 (68.50)
405-13-80S-R29-L14	93S	10	13	1.200 (30.48)	.100 (2.54)	1.297 (32.94)	405-27-80S-R29-L14	93S	10	27	2.600 (66.04)	.100 (2.54)	2.697 (68.50)
405-14-01S-R29-L14	93S	10	14	1.300 (33.02)	.100 (2.54)	1.397 (35.48)	405-28-01S-R29-L14	93S	10	28	2.700 (68.58)	.100 (2.54)	2.797 (71.04)
405-14-80S-R29-L14	93S	10	14	1.300 (33.02)	.100 (2.54)	1.397 (35.48)	405-28-80S-R29-L14	93S	10	28	2.700 (68.58)	.100 (2.54)	2.797 (71.04)
405-14-88S-R29-L14	93S	10	14	1.300 (33.02)	.100 (2.54)	1.397 (35.48)	405-29-01S-R29-L14	93S	10	29	2.800 (71.12)	.100 (2.54)	2.897 (73.58)
405-15-01S-R29-L14	93S	10	15	1.400 (35.56)	.100 (2.54)	1.497 (38.02)	405-29-80S-R29-L14	93S	10	29	2.800 (71.12)	.100 (2.54)	2.897 (73.58)
405-15-80S-R29-L14	93S	10	15	1.400 (35.56)	.100 (2.54)	1.497 (38.02)	405-30-01S-R29-L14	93S	10	30	2.900 (73.66)	.100 (2.54)	2.997 (76.12)
405-16-01S-R29-L14	93S	10	16	1.500 (38.10)	.100 (2.54)	1.597 (40.56)	405-30-80S-R29-L14	93S	10	30	2.900 (73.66)	.100 (2.54)	2.997 (76.12)

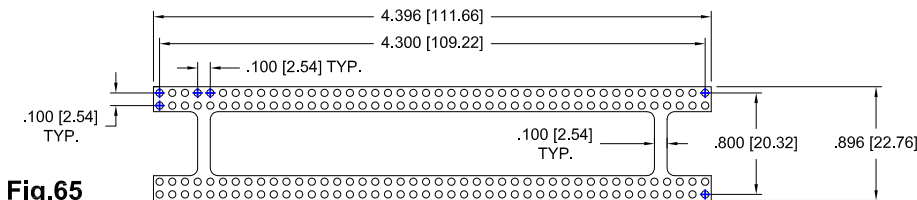

Fig.65

176 Pins
Thru-Hole: IS229-8176D-01M-R29-L14-A
Surface Mount: IS229-8176D-93M-R29-L14-A

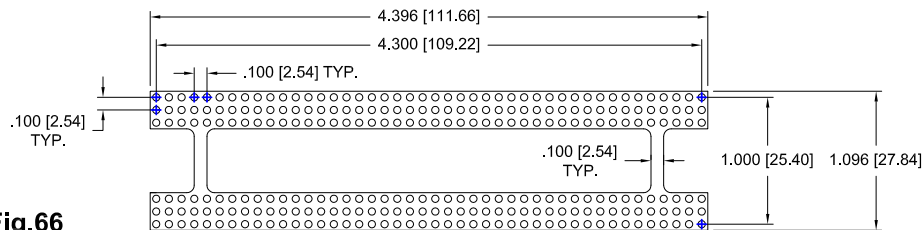

Fig.66

264 Pins
Thru-Hole: IS229-10264T-01M-R29-L14-A
Surface Mount: IS229-10264T-93M-R29-L14-A

For Other Pin Configuration or Layouts, Contact Factory.

RoHS Compliant
Andon Proprietary Information
IS-13A 03/15/13

©Copyright 2013 Andon Electronics Corporation. All Rights Reserved. This material is protected under US and other copyrights and may not be copied, sold, or redistributed in any form without written permission of Andon Electronics Corporation. Copyrights and trademarks are property of their respective companies. We reserve the right to change specifications without notice. Andon makes no warranty, expressed or implied, as to the suitability of the sockets for the intended purpose.

.100 [2.54] Pitch Image Sensor PGA Sockets

[Back to Table of Contents](#)

For Terminal Details or other Terminal Types see Page 26

Socket Top View Shown
Units: in [mm]

.100 [2.54] Pitch

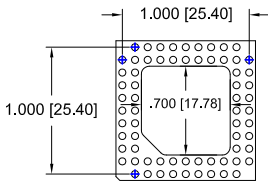

Fig. 15
68 Pins

Thru-Hole: 575-11-42-068-01M-R29-L14
Surface Mount: 575-11-42-068-93M-R29-L14

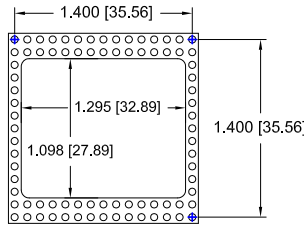

Fig. 19
82 Pins

Thru-Hole: 575-15-62-082-80M-R29-L14
Surface Mount: 575-15-62-082-93M-R29-L14

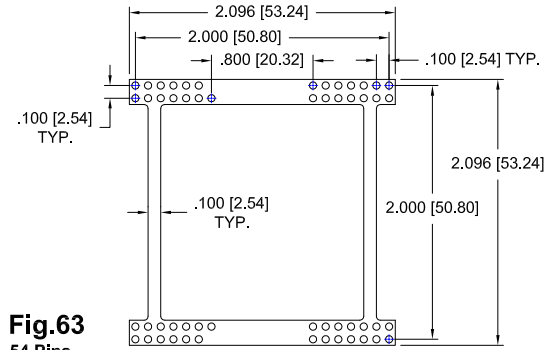

Fig. 63
54 Pins

Thru-Hole: IS231-2054D-01M-R29-L14-A
Surface Mount: IS231-2054D-93M-R29-L14-A

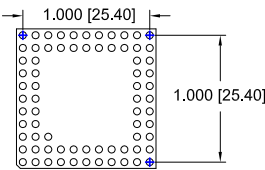

Fig. 16
73 Pins

Thru-Hole: 575-11-57-073-01M-R29-L14
Surface Mount: 575-11-57-073-93M-R29-L14

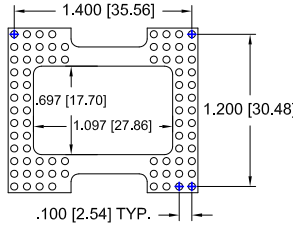

Fig. 20
80 Pins

Thru-Hole: 575-15-63-080-01M-R29-L14
Surface Mount: 575-15-63-080-93M-R29-L14

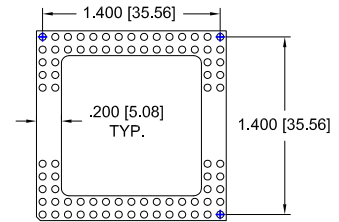

Fig. 24
84 Pins

Thru-Hole: 575-15-65-084-01M-R29-L14
Surface Mount: 575-15-65-084-93M-R29-L14

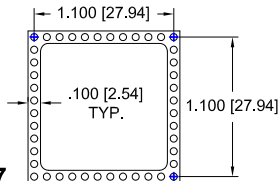

Fig. 17
44 Pins

Thru-Hole: 575-12-22-044-88M-R29-L14
Surface Mount: 575-12-22-044-93M-R29-L14

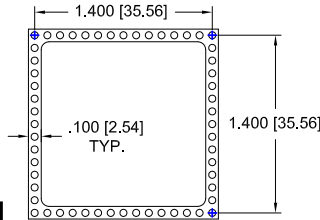

Fig. 21
56 Pins

Thru-Hole: 575-15-64-056-88M-R29-L14
Surface Mount: 575-15-64-056-93M-R29-L14

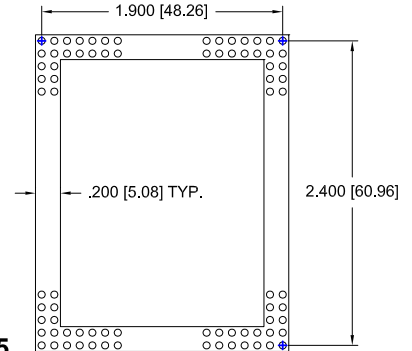

Fig. 25
80 Pins

Thru-Hole: 575-25-04-080-01M-R29-L14
Surface Mount: 575-25-04-080-93M-R29-L14

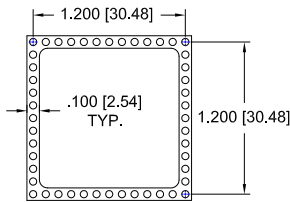

Fig. 18
48 Pins

Thru-Hole: 575-13-83-048-80M-R29-L14
Surface Mount: 575-13-83-048-93M-R29-L14

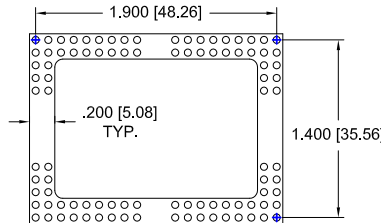

Fig. 22
96 Pins

Thru-Hole: 575-20-16-096-01M-R29-L14
Surface Mount: 575-20-16-096-93M-R29-L14

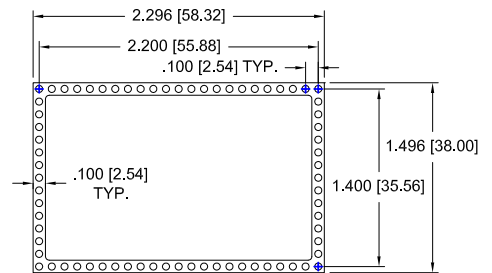

Fig. 62
72 Pins

Thru-Hole: 575-23-03-072-01M-R29-L14
Surface Mount: 575-23-03-072-93M-R29-L14

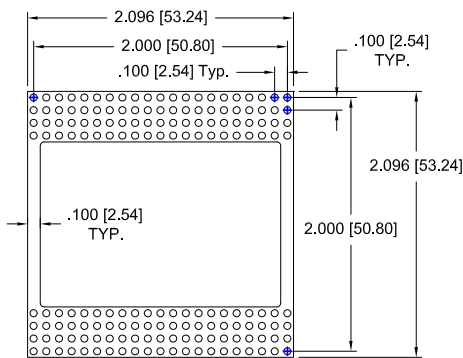

Fig. 61
168 Pins

Thru-Hole: 575-21-14-168-80M-R29-L14
Surface Mount: 575-21-14-168-93M-R29-L14

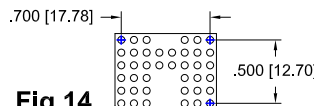

Fig. 14
40 Pins

Thru-Hole: 575-08-04-040-80M-R29-L14
Surface Mount: 575-08-04-040-93M-R29-L14

For Other Pin Configuration or Layouts, Contact Factory.

RoHS Compliant

Andon Proprietary Information

IS-13A 03/15/13

©Copyright 2013 Andon Electronics Corporation. All Rights Reserved. This material is protected under US and other copyrights and may not be copied, sold, or redistributed in any form without written permission of Andon Electronics Corporation. Copyrights and trademarks are property of their respective companies. We reserve the right to change specifications without notice. Andon makes no warranty, expressed or implied, as to the suitability of the sockets for the intended purpose.

.100 [2.54] Pitch Image Sensor PGA Sockets

[Back to Table of Contents](#)

Top View Shown
Units: in [mm]

.100 [2.54] Pitch

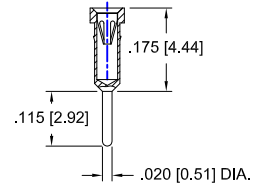

- 01 Terminal Shown

For Terminal Details or other Terminal Types see Page 26

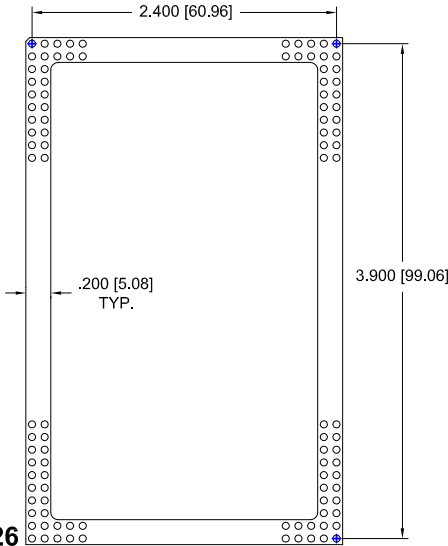

Fig.26
104 Pins

Thru-Hole: 575-40-02-104-01M-R29-L14
Surface Mount: 575-40-02-104-93M-R29-L14

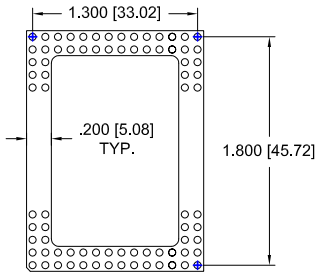

Fig.27
88 Pins

Thru-Hole: 575-19-27-088-01M-R29-L14
Surface Mount: 575-19-27-088-93M-R29-L14

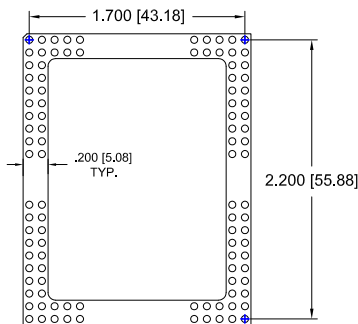

Fig.28
104 Pins

Thru-Hole: 575-23-02-104-01M-R29-L14
Surface Mount: 575-23-02-104-93M-R29-L14

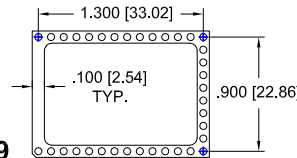

Fig.29
36 Pins

Thru-Hole: 575-14-39-036-01S-R29-L14
Surface Mount: 575-14-39-036-93S-R29-L14

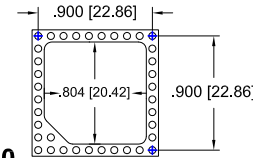

Fig.30
37 Pins

Thru-Hole: 575-10-19-037-01S-R29-L14
Surface Mount: 575-10-19-037-93S-R29-L14

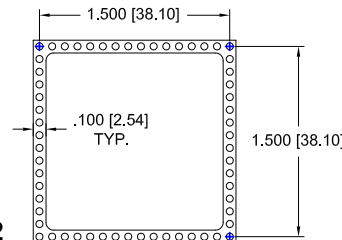

Fig.32
60 Pins

Thru-Hole: 575-16-25-060-88M-R29-L14
Surface Mount: 575-16-25-060-93M-R29-L14

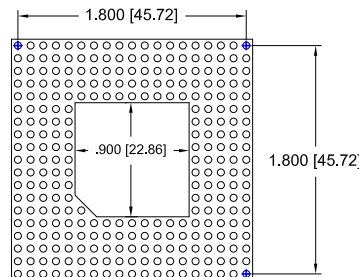

Fig.33
281 Pins

Thru-Hole: 575-19-25-281-01M-R29-L14
Surface Mount: 575-19-25-281-93M-R29-L14

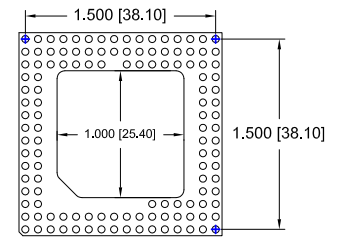

Fig.35
127 Pins

Thru-Hole: 575-16-24-127-01M-R29-L14
Surface Mount: 575-16-24-127-93M-R29-L14

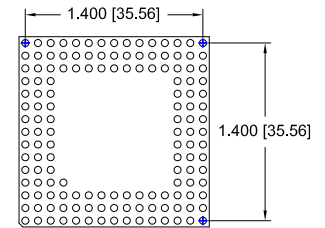

Fig.36
145 Pins

Thru-Hole: 575-15-28-145-01M-R29-L14
Surface Mount: 575-15-28-145-93M-R29-L14

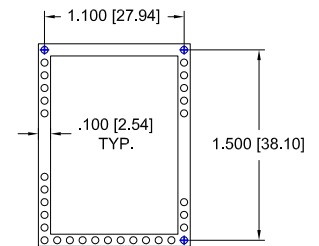

Fig.46
32 Pins

Thru-Hole: 575-16-26-032-01S-R29-L14
Surface Mount: 575-16-26-032-93S-R29-L14

For Other Pin Configuration or Layouts, Contact Factory.

RoHS Compliant

Andon Proprietary Information

IS-13A 03/15/13

©Copyright 2013 Andon Electronics Corporation. All Rights Reserved. This material is protected under US and other copyrights and may not be copied, sold, or redistributed in any form without written permission of Andon Electronics Corporation. Copyrights and trademarks are property of their respective companies. We reserve the right to change specifications without notice. Andon makes no warranty, expressed or implied, as to the suitability of the sockets for the intended purpose.

.070 [1.78] Pitch Image Sensor DIP Sockets

[Back to Table of Contents](#)

Top View Shown
Units: in [mm]

Fig.6

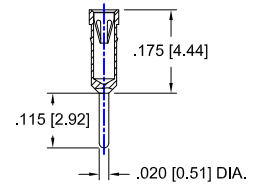
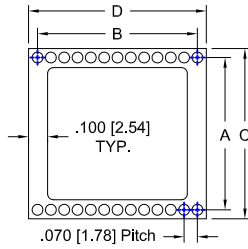

- 75 Terminal Shown

For Terminal Details or other Terminal Types see Page 26

Andon Part Number w/Thru-Hole Terminal	Surface Mount Terminal	Figure Number	Pin QTY.	A	B	C	D
IS230-416-75S-R29-L14	384S	6	16	.400 (10.16)	.490 (12.45)	.497 (12.62)	.587 (14.91)
IS230-420-75S-R29-L14	384S	6	20	.400 (10.16)	.630 (16.00)	.497 (12.62)	.727 (18.47)
IS230-4512-75S-R29-L14	384S	6	12	.450 (11.43)	.350 (8.89)	.547 (13.89)	.447 (11.35)
IS230-532-75S-R29-L14	384S	6	32	.500 (12.70)	1.050 (26.67)	.597 (15.16)	1.147 (29.13)
IS230-620-75S-R29-L14	384S	6	20	.600 (15.24)	.630 (16.00)	.697 (17.70)	.727 (18.47)
IS230-632-75S-R29-L14	384S	6	32	.600 (15.24)	1.050 (26.67)	.697 (17.70)	1.147 (29.13)
IS230-828-75S-R29-L14	384S	6	28	.800 (20.32)	.910 (23.11)	.897 (22.78)	1.007 (25.58)
IS230-832-75S-R29-L14	384S	6	32	.800 (20.32)	1.050 (26.67)	.897 (22.78)	1.147 (29.13)
IS230-930-75S-R29-L14	384S	6	30	.900 (22.86)	.980 (24.89)	.997 (25.32)	1.077 (27.36)
IS230-934-75S-R29-L14	384S	6	34	.900 (22.86)	1.120 (28.45)	.997 (25.32)	1.217 (30.91)
IS230-1034-75S-R29-L14	384S	6	34	1.000 (25.40)	1.120 (28.45)	1.097 (27.86)	1.217 (30.91)
IS230-1232-75S-R29-L14	384S	6	32	1.200 (30.48)	1.050 (26.67)	1.297 (32.94)	1.147 (29.13)
IS230-1232-400T4-R29-L14	414T4	6	32	1.200 (30.48)	1.050 (26.67)	1.297 (32.94)	1.147 (29.13)
IS230-1340-75S-R29-L14	384S	6	40	1.300 (33.02)	1.330 (33.78)	1.397 (35.48)	1.427 (36.25)
IS230-18860-75M-R29-L14	384M	6	60	1.880 (47.75)	2.030 (51.56)	1.977 (50.22)	2.127 (54.03)
IS230-2064-75M-R29-L14	384M	6	64	2.000 (50.80)	2.170 (55.12)	2.097 (53.26)	2.267 (57.58)
IS230-2640-75S-R29-L14	384S	6	40	2.600 (66.04)	1.330 (33.78)	2.697 (68.50)	1.427 (36.25)

.070 [1.78] Pitch

Fig.6A

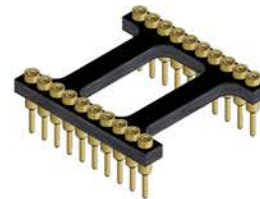
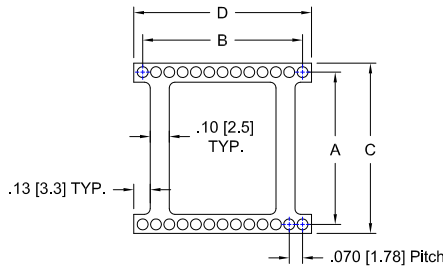

Andon Part Number w/Thru-Hole Terminal	Surface Mount Terminal	Figure Number	Pin QTY.	A	B	C	D
IS230-620-75S-R29-L14-A	384S	6A	20	.600 (15.24)	.630 (16.00)	.697 (17.70)	.727 (18.47)
IS230-724-75S-R29-L14-A	384S	6A	24	.700 (17.78)	.770 (19.56)	.797 (20.24)	.867 (22.02)
IS230-832-75S-R29-L14-A	384S	6A	32	.800 (20.32)	1.050 (26.67)	.897 (22.78)	1.147 (29.13)
IS230-1034-75S-R29-L14-A	384S	6A	34	1.010 (25.65)	1.120 (28.45)	1.107 (28.12)	1.217 (30.91)

Fig.67
68 Pins

Thru-Hole: IS230D-6968SP-443M-R29-L14-A
Surface Mount: IS230D-6968SP-384M-R29-L14-A

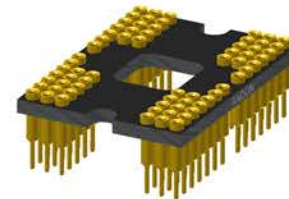
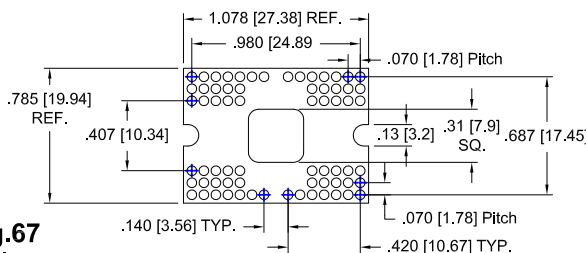

For Other Pin Configuration or Layouts, Contact Factory.

RoHS Compliant
Andon Proprietary Information
IS-13A 03/15/13

.070 [1.78] Pitch Image Sensor DIP Sockets

[Back to Table of Contents](#)

Top View Shown
Units: in [mm]

Fig.6B

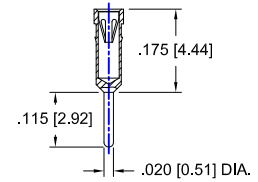
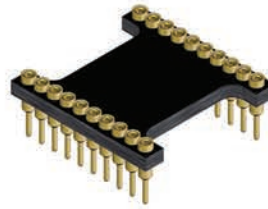
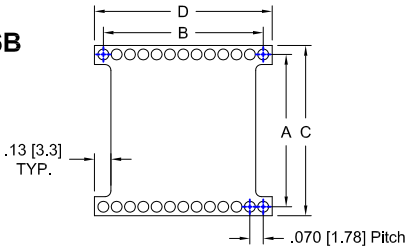

- 75 Terminal
Shown

For Terminal Details or other
Terminal Types see Page 26

Andon Part Number w/Thru-Hole Terminal	Surface Mount Terminal	Figure Number	Pin QTY.	A	B	C	D
IS230-624-75S-R29-L14-B	384S	6B	24	.600 (15.24)	.770 (19.56)	.697 (17.70)	0.867 (22.02)
IS230-832-75S-R29-L14-B	384S	6B	32	.800 (20.32)	1.050 (26.67)	.897 (22.78)	1.147 (29.13)

.070 [1.78] Pitch

Fig. 9

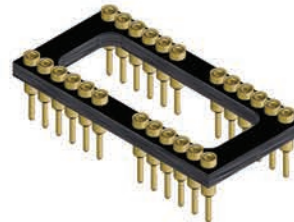
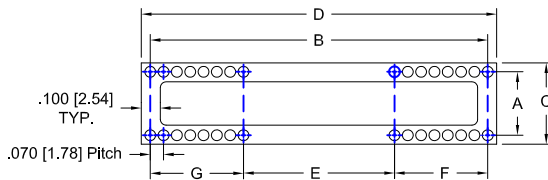

Andon Part Number w/Thru-Hole Terminal	Surface Mount Terminal	Figure Number	Pin QTY.	A	B	C	D	E	F	G
IS233-4146-75M-R29-L14	384M	9	46	.410 (10.41)	2.200 (55.88)	.507 (12.88)	2.297 (58.34)	.730 (18.54)	.770 (19.56)	.700 (17.78)
IS233-424-75S-R29-L14	384S	9	24	.400 (10.16)	.910 (23.11)	.497 (12.62)	1.007 (25.58)	.210 (5.33)	.350 (8.89)	.350 (8.89)
IS233-532-75S-R29-L14	384S	9	32	.500 (12.70)	2.170 (55.12)	.597 (15.16)	2.267 (57.58)	1.190 (30.23)	.490 (12.45)	.490 (12.45)

.070 [1.78] Pitch Image Sensor Dual Row DIP Sockets

Top View Shown
Units: in [mm]

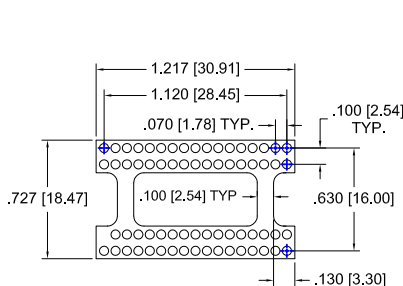

Fig.38

67 Pins

Thru-Hole: IS230-6367D-75M-R29-L14-A
Surface Mount: IS230-6367D-265M-R29-L14-A

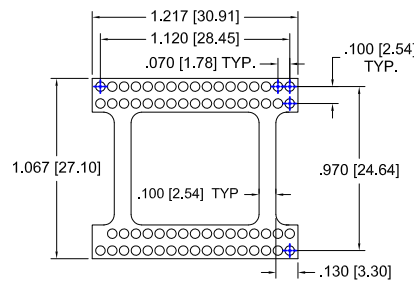

Fig.40

67 Pins

Thru-Hole: IS230-9767D-75M-R29-L14-A
Surface Mount: IS230-9767D-265M-R29-L14-A

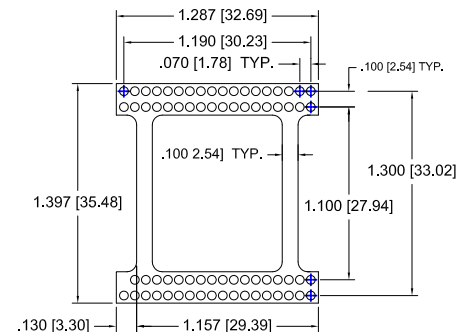

Fig.54

71 Pins

Thru-Hole: IS230-1371D-75M-R29-L14-A
Surface Mount: IS230-1371D-265M-R29-L14-A

For Other Pin Configuration or Layouts, Contact Factory.

RoHS Compliant
Andon Proprietary Information
IS-13A 03/15/13

©Copyright 2013 Andon Electronics Corporation. All Rights Reserved. This material is protected under US and other copyrights and may not be copied, sold, or redistributed in any form without written permission of Andon Electronics Corporation. Copyrights and trademarks are property of their respective companies. We reserve the right to change specifications without notice. Andon makes no warranty, expressed or implied, as to the suitability of the sockets for the intended purpose.

.070 [1.78] Pitch Image Sensor Dual and Triple Device DIP Sockets [Back to Table of Contents](#)

Top View Shown
Units: in [mm]

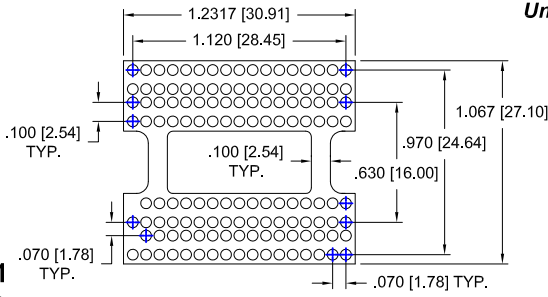

Fig.41
134 Pins

Thru-Hole: IS230D-97134-75M-R29-L14-A
Surface Mount: IS230D-97134-265M-R29-L14-A

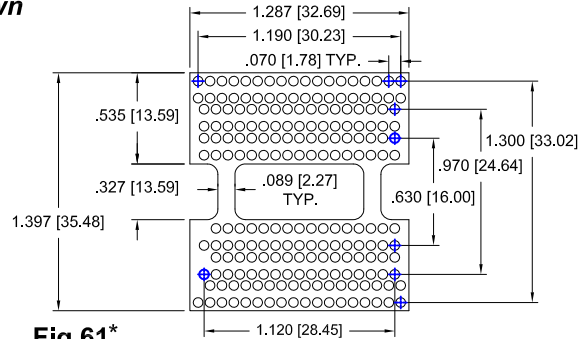
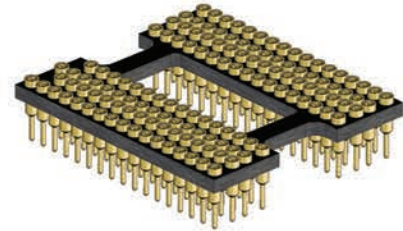

Fig.61*
205 Pins

Thru-Hole: IS230T-13205-75M-R29-L14-A
Surface Mount: IS230T-13205-265M-R29-L14-A



For Terminal Details or other
Terminal Types see Page 26

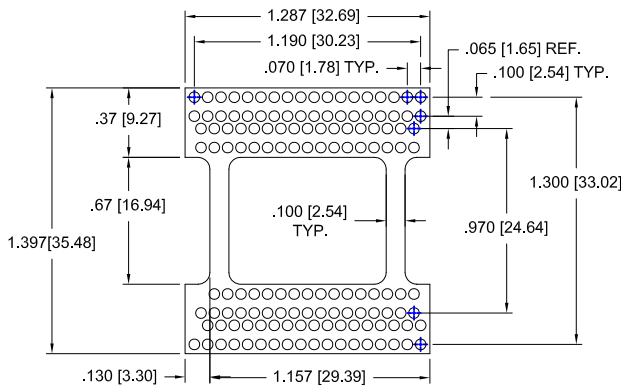

Fig.68
138 Pins

Thru-Hole: IS230D-13138-75M-R29-L14-A
Surface Mount: IS230D-13138-384M-R29-L14-A

*accepts KAI-01050, KAI-02050, KAI-02150, KAI-04050, KAI-08050, KAI-29050, or KAI1603

.070 [1.78] Pitch Image Sensor SIP Sockets

Top View Shown
Units: in [mm]

Fig.12

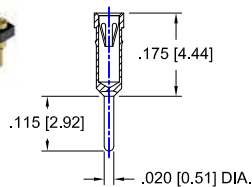
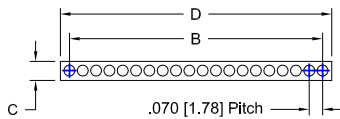

**- 75 Terminal
Shown**

For Terminal Details or other
Terminal Styles see Page 26

Andon Part Number w/Thru-hole Terminal	Surface Mount Terminal	Figure Number	Pin QTY.	B	C	D
416-03-75S-R29-L14	384S	12	3	.140 (3.56)	.100 (2.54)	.237 (6.02)
416-04-75S-R29-L14	384S	12	4	.210 (5.33)	.100 (2.54)	.307 (7.80)
416-05-75S-R29-L14	384S	12	5	.280 (7.11)	.100 (2.54)	.377 (9.58)
416-06-75S-R29-L14	384S	12	6	.350 (8.89)	.100 (2.54)	.447 (11.35)
416-07-75S-R29-L14	384S	12	7	.420 (10.67)	.100 (2.54)	.517 (13.13)
416-08-75S-R29-L14	384S	12	8	.490 (12.45)	.100 (2.54)	.587 (14.91)
416-09-75S-R29-L14	384S	12	9	.560 (14.22)	.100 (2.54)	.657 (16.69)
416-10-75S-R29-L14	384S	12	10	.630 (16.00)	.100 (2.54)	.727 (18.47)
416-11-75S-R29-L14	384S	12	11	.700 (17.78)	.100 (2.54)	.797 (20.24)
416-12-75S-R29-L14	384S	12	12	.770 (19.56)	.100 (2.54)	.867 (22.02)
416-13-75S-R29-L14	384S	12	13	.840 (21.34)	.100 (2.54)	.937 (23.80)
416-14-75S-R29-L14	384S	12	14	.910 (23.11)	.100 (2.54)	1.007 (25.58)
416-15-75S-R29-L14	384S	12	15	.980 (24.89)	.100 (2.54)	1.077 (27.36)
416-16-75S-R29-L14	384S	12	16	1.050 (26.67)	.100 (2.54)	1.147 (29.13)
416-17-75S-R29-L14	384S	12	17	1.120 (28.45)	.100 (2.54)	1.217 (30.91)
416-18-75S-R29-L14	384S	12	18	1.190 (30.23)	.100 (2.54)	1.287 (32.69)
416-19-75S-R29-L14	384S	12	19	1.260 (32.00)	.100 (2.54)	1.357 (34.47)
416-20-75S-R29-L14	384S	12	20	1.330 (33.78)	.100 (2.54)	1.427 (36.25)
416-21-75S-R29-L14	384S	12	21	1.400 (35.56)	.100 (2.54)	1.497 (38.02)
416-22-75S-R29-L14	384S	12	22	1.470 (37.34)	.100 (2.54)	1.567 (39.80)
416-23-75S-R29-L14	384S	12	23	1.540 (39.12)	.100 (2.54)	1.637 (41.58)
416-24-75S-R29-L14	384S	12	24	1.610 (40.89)	.100 (2.54)	1.707 (43.36)
416-25-75S-R29-L14	384S	12	25	1.680 (42.67)	.100 (2.54)	1.777 (45.14)
416-26-75S-R29-L14	384S	12	26	1.750 (44.45)	.100 (2.54)	1.847 (46.91)
416-27-75S-R29-L14	384S	12	27	1.820 (46.23)	.100 (2.54)	1.917 (48.69)
416-28-75S-R29-L14	384S	12	28	1.890 (48.01)	.100 (2.54)	1.987 (50.47)
416-29-75S-R29-L14	384S	12	29	1.960 (49.78)	.100 (2.54)	2.057 (52.25)
416-30-75S-R29-L14	384S	12	30	2.030 (51.56)	.100 (2.54)	2.127 (54.03)

For Other Pin Configuration or Layouts, Contact Factory.

RoHS Compliant

Andon Proprietary Information

IS-13A 03/15/13

©Copyright 2013 Andon Electronics Corporation. All Rights Reserved. This material is protected under US and other copyrights and may not be copied, sold, or redistributed in any form without written permission of Andon Electronics Corporation. Copyrights and trademarks are property of their respective companies. We reserve the right to change specifications without notice. Andon makes no warranty, expressed or implied, as to the suitability of the sockets for the intended purpose.

.050 [1.27] Pitch Image Sensor DIP Sockets

[Back to Table of Contents](#)

Top View Shown
Units: in [mm]

Fig.8

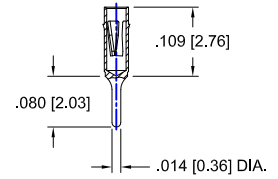
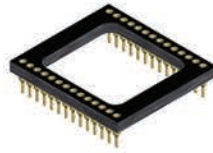
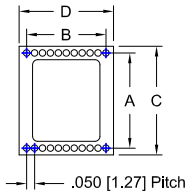

For Terminal Details or other Terminal Types see Page 26

- 274 Terminal Shown

Andon Part Number w/Thru-Hole Terminal	Surface Mount Terminal	Figure Number	Pin QTY.	A	B	C	D
IS232-316-274U-R27-L14	281U	8	16	.300 (7.62)	.350 (8.89)	.385 (9.78)	.447 (11.35)
IS232-414-274U-R27-L14	281U	8	14	.400 (10.16)	.300 (7.62)	.485 (12.32)	.397 (10.08)
IS232-416-274U-R27-L14	281U	8	16	.400 (10.16)	.350 (8.89)	.485 (12.32)	.447 (11.35)
IS232-440-274U-R27-L14	281U	8	40	.400 (10.16)	.950 (24.13)	.485 (12.32)	1.047 (26.59)
IS232-4516-274U-R27-L14	281U	8	16	.450 (11.43)	.350 (8.89)	.535 (13.59)	.447 (11.35)
IS232-4820-274U-R27-L14	281U	8	20	.480 (12.19)	.450 (11.43)	.565 (14.35)	.547 (13.89)
IS232-520-274U-R27-L14	281U	8	20	.500 (12.70)	.450 (11.43)	.585 (14.86)	.547 (13.89)
IS232-522-274U-R27-L14	281U	8	22	.500 (12.70)	.500 (12.70)	.585 (14.86)	.597 (15.16)
IS232-5724-274U-R27-L14	281U	8	24	.570 (14.48)	.550 (13.97)	.655 (16.64)	.647 (16.43)
IS232-622-274U-R27-L14	281U	8	22	.600 (15.24)	.500 (12.70)	.685 (17.40)	.597 (15.16)
IS232-628-274U-R27-L14	281U	8	28	.600 (15.24)	.650 (16.51)	.685 (17.40)	.747 (18.97)

.050 [1.27] Pitch Image Sensor SIP Sockets

Top View Shown
Units: in [mm]

Fig.13

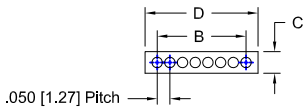

Andon Part Number w/Thru-hole Terminal	Surface Mount Terminal	Figure Number	Pin QTY.	B	C	D
417-05-274U-R27-L14	281U	13	5	.200 (5.08)	.085 (2.16)	.297 (7.54)
417-06-274U-R27-L14	281U	13	6	.250 (6.35)	.085 (2.16)	.347 (8.81)
417-07-274U-R27-L14	281U	13	7	.300 (7.62)	.085 (2.16)	.397 (10.08)
417-08-274U-R27-L14	281U	13	8	.350 (8.89)	.085 (2.16)	.447 (11.35)
417-09-274U-R27-L14	281U	13	9	.400 (10.16)	.085 (2.16)	.497 (12.62)
417-10-274U-R27-L14	281U	13	10	.450 (11.43)	.085 (2.16)	.547 (13.89)
417-11-274U-R27-L14	281U	13	11	.500 (12.70)	.085 (2.16)	.597 (15.16)
417-12-274U-R27-L14	281U	13	12	.550 (13.97)	.085 (2.16)	.647 (16.43)
417-13-274U-R27-L14	281U	13	13	.600 (15.24)	.085 (2.16)	.697 (17.70)
417-14-274U-R27-L14	281U	13	14	.650 (16.51)	.085 (2.16)	.747 (18.97)
417-15-274U-R27-L14	281U	13	15	.700 (17.78)	.085 (2.16)	.797 (20.24)
417-16-274U-R27-L14	281U	13	16	.750 (19.05)	.085 (2.16)	.847 (21.51)
417-17-274U-R27-L14	281U	13	17	.800 (20.32)	.085 (2.16)	.897 (22.78)
417-18-274U-R27-L14	281U	13	18	.850 (21.59)	.085 (2.16)	.947 (24.05)
417-19-274U-R27-L14	281U	13	19	.900 (22.86)	.085 (2.16)	.997 (25.32)
417-20-274U-R27-L14	281U	13	20	.950 (24.13)	.085 (2.16)	1.047 (26.59)
417-21-274U-R27-L14	281U	13	21	1.000 (25.40)	.085 (2.16)	1.097 (27.86)
417-22-274U-R27-L14	281U	13	22	1.050 (26.67)	.085 (2.16)	1.147 (29.13)
417-23-274U-R27-L14	281U	13	23	1.100 (27.94)	.085 (2.16)	1.197 (30.40)
417-24-274U-R27-L14	281U	13	24	1.150 (29.21)	.085 (2.16)	1.247 (31.67)
417-25-274U-R27-L14	281U	13	25	1.200 (30.48)	.085 (2.16)	1.297 (32.94)
417-26-274U-R27-L14	281U	13	26	1.250 (31.75)	.085 (2.16)	1.347 (34.21)
417-27-274U-R27-L14	281U	13	27	1.300 (33.02)	.085 (2.16)	1.397 (35.48)
417-28-274U-R27-L14	281U	13	28	1.350 (34.29)	.085 (2.16)	1.447 (36.75)
417-29-274U-R27-L14	281U	13	29	1.400 (35.56)	.085 (2.16)	1.497 (38.02)
417-30-274U-R27-L14	281U	13	30	1.450 (36.83)	.085 (2.16)	1.547 (39.29)

For Other Pin Configuration or Layouts, Contact Factory.

RoHS Compliant

Andon Proprietary Information

IS-13A 03/15/13

©Copyright 2013 Andon Electronics Corporation. All Rights Reserved. This material is protected under US and other copyrights and may not be copied, sold, or redistributed in any form without written permission of Andon Electronics Corporation. Copyrights and trademarks are property of their respective companies. We reserve the right to change specifications without notice. Andon makes no warranty, expressed or implied, as to the suitability of the sockets for the intended purpose.

.050 [1.27] Pitch Image Sensor BGA Sockets

Top View Shown Units: in [mm]

[Back to Table of Contents](#)

For Terminal Details or other Terminal Types see Page 26

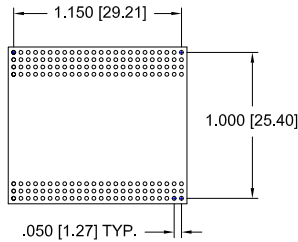

Fig. 5

168 Pins
Thru-Hole: 10-24-05-168-400T4-R27-L14
Surface Mount: 10-24-05-168-414T4-R27-L14
Surface Mount: 10-24-05-168-RB501T4-R27-L14

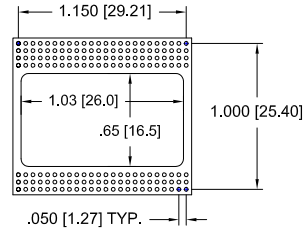

Fig. 58

168 Pins
Thru-Hole: 10-24-05A-168-400T4-R27-L14
Surface Mount: 10-24-05A-168-414T4-R27-L14
Surface Mount: 10-24-05A-168-RB501T4-R27-L14

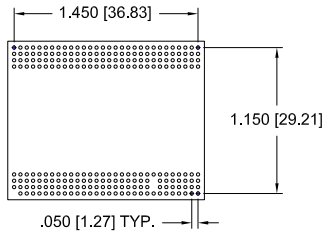

Fig. 48

237 Pins
Thru-Hole: 10-30-07-237-400T4-R27-L14
Surface Mount: 10-30-07-237-414T4-R27-L14
Surface Mount: 10-30-07-237-RB501T4-R27-L14

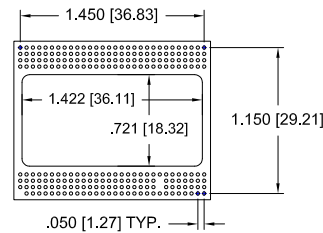

Fig. 59

237 Pins
Thru-Hole: 10-30-07A-237-400T4-R27-L14
Surface Mount: 10-30-07A-237-414T4-R27-L14
Surface Mount: 10-30-07A-237-RB501T4-R27-L14

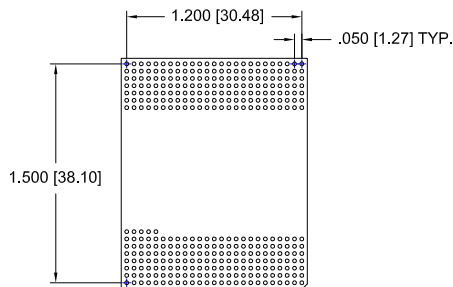

Fig. 56

355 Pins
Thru-Hole: 10-31-13-355-400T4-R27-L14
Surface Mount: 10-31-13-355-414T4-R27-L14
Surface Mount: 10-31-13-355-RB501T4-R27-L14

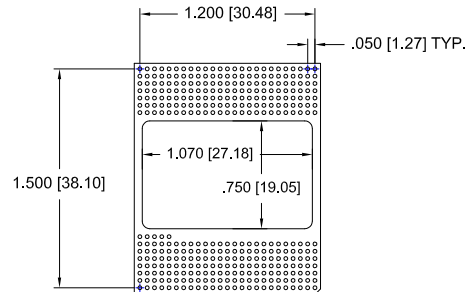

Fig. 60

355 Pins
Thru-Hole: 10-31-13A-355-400T4-R27-L14
Surface Mount: 10-31-13A-355-414T4-R27-L14
Surface Mount: 10-31-13A-355-RB501T4-R27-L14

For Other Pin Configuration or Layouts, Contact Factory.

RoHS Compliant

Andon Proprietary Information

IS-13A 03/15/13

©Copyright 2013 Andon Electronics Corporation. All Rights Reserved. This material is protected under US and other copyrights and may not be copied, sold, or redistributed in any form without written permission of Andon Electronics Corporation. Copyrights and trademarks are property of their respective companies. We reserve the right to change specifications without notice. Andon makes no warranty, expressed or implied, as to the suitability of the sockets for the intended purpose.

.050 [1.27] Pitch Image Sensor BGA Sockets

Top View Shown Units: in [mm]

For Terminal Details or other Terminal Types see Page 26

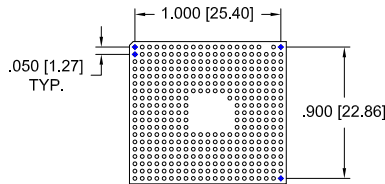

Fig. 55
369 Pins

Thru-Hole: 10-21-06-369-400T4-R27-L14
Surface Mount: 10-21-06-369-414T4-R27-L14

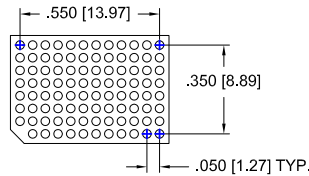

Fig. 47
95 Pins

Thru-Hole: 10-12-06-095-400T4-R27-L14
Surface Mount: 10-12-06-095-414T4-R27-L14

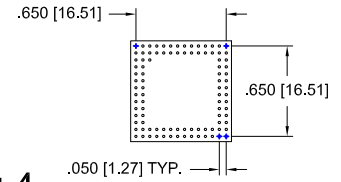

Fig. 4
97 Pins

Thru-Hole: 10-14-11-097-400T4-R27-L14
Surface Mount: 10-14-11-097-414T4-R27-L14

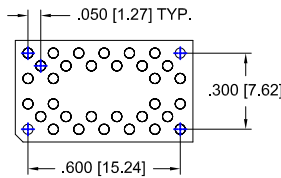

Fig. 31
34 Pins

Thru-Hole: 585-07-02-034-211M-R29-L14
Surface Mount: 585-07-02-034-265M-R29-L14

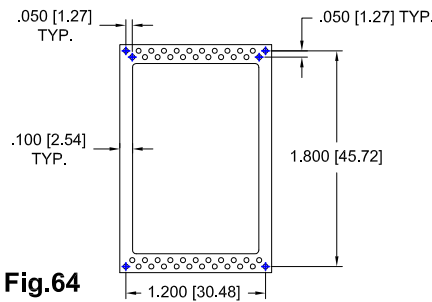

Fig. 64
46 Pins

Thru-Hole: 585-18-12-046-211M-R29-L14
Surface Mount: 585-18-12-046-265M-R29-L14

Round Image Sensor Sockets

[Other Figures available, see our "Optoelectronic Catalog" at www.andonelect.com]

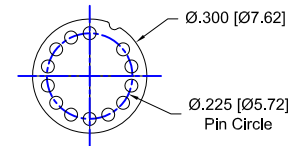

Fig. 34
13 Pins

Thru-Hole: R225-1413-01N-400T4-R27-L14
Surface Mount: R225-1413-01N-414T4-R27-L14

.0437 [1.11] Pitch Image Sensor DIP Sockets

Top View Shown
Units: in [mm]

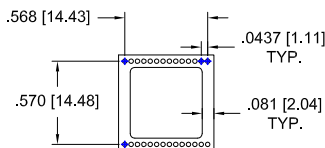

Fig. 44
28 Pins

Thru-Hole: IS0437SP-5728-C4-G10-L14
Surface Mount: N/A

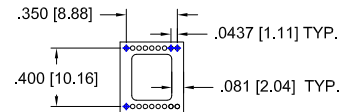

Fig. 45
18 Pins

Thru-Hole: IS0437SP-418-C4-G10-L14
Surface Mount: N/A

.0437 [1.11] Pitch Image Sensor SIP Sockets

Top View Shown
Units: in [mm]

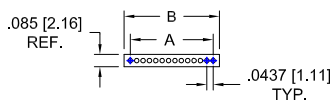

Fig. 69

Andon Part # w/Thru-Hole Terminal	Figure #	Pin QTY.	A	B	Andon Part # w/Thru-Hole Terminal	Figure #	Pin QTY.	A	B
419-04-C4-G10-L14	69	4	.131 (3.33)	.217 (5.51)	419-17-C4-G10-L14	69	17	.699 (17.75)	.785 (19.94)
419-05-C4-G10-L14	69	5	.175 (4.45)	.261 (6.63)	419-18-C4-G10-L14	69	18	.743 (18.87)	.829 (21.06)
419-06-C4-G10-L14	69	6	.219 (5.56)	.305 (7.75)	419-19-C4-G10-L14	69	19	.787 (19.99)	.873 (22.17)
419-07-C4-G10-L14	69	7	.262 (6.65)	.348 (8.84)	419-20-C4-G10-L14	69	20	.830 (21.08)	.916 (23.27)
419-08-C4-G10-L14	69	8	.306 (7.77)	.392 (9.96)	419-21-C4-G10-L14	69	21	.874 (22.20)	.960 (24.38)
419-09-C4-G10-L14	69	9	.350 (8.89)	.436 (11.07)	419-22-C4-G10-L14	69	22	.918 (23.32)	1.004 (25.50)
419-10-C4-G10-L14	69	10	.393 (9.98)	.479 (12.17)	419-23-C4-G10-L14	69	23	.961 (24.41)	1.047 (26.59)
419-11-C4-G10-L14	69	11	.437 (11.10)	.523 (13.28)	419-24-C4-G10-L14	69	24	1.005 (25.53)	1.091 (27.71)
419-12-C4-G10-L14	69	12	.481 (12.22)	.567 (14.40)	419-25-C4-G10-L14	69	25	1.049 (26.64)	1.135 (28.83)
419-13-C4-G10-L14	69	13	.524 (13.31)	.610 (15.49)	419-26-C4-G10-L14	69	26	1.093 (27.76)	1.179 (29.95)
419-14-C4-G10-L14	69	14	.568 (14.43)	.654 (16.61)	419-27-C4-G10-L14	69	27	1.136 (28.85)	1.222 (31.04)
419-15-C4-G10-L14	69	15	.612 (15.54)	.698 (17.73)	419-28-C4-G10-L14	69	28	1.180 (29.97)	1.266 (32.16)
419-16-C4-G10-L14	69	16	.656 (16.66)	.742 (18.85)	419-29-C4-G10-L14	69	29	1.224 (31.09)	1.310 (33.27)
					419-30-C4-G10-L14	69	30	1.267 (32.18)	1.353 (34.37)

For Other Pin Configuration or Layouts, Contact Factory.

RoHS Compliant

Andon Proprietary Information

IS-13A 03/15/13

For Terminal Details or other Terminal Types see Page 26 [Back to Table of Contents](#)

.0295 [0.75] Pitch UBGA Sockets

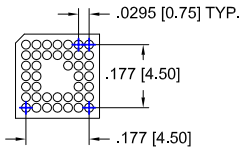

Fig. 50
41 Pins
Thru-Hole: 18-07-03-041-437T-R27-L10
Surface Mount: 18-07-03-041-329T-R27-L10
Adapter: 18-07-03-041-413-G10-L14

.0394 [1.00] Pitch BGA Sockets

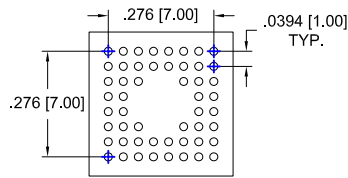

Fig. 51
52 Pins
Thru-Hole: 12-08-02-052-347T-P27-L14
Surface Mount: 12-08-02-052-319T-P27-L14
Adapter: 12-08-02-052-321-G10-L14

.0276 [0.70] Pitch iLCC LGA Test Socket

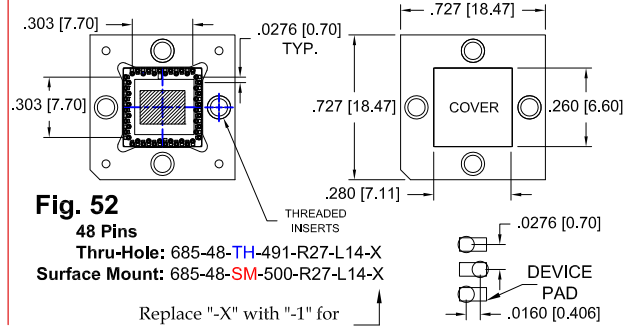

Fig. 52
48 Pins
Thru-Hole: 685-48-TH-491-R27-L14-X
Surface Mount: 685-48-SM-500-R27-L14-X
Replace "-X" with "-1" for index pins or "-0" for none

.0315 [0.80] Pitch LCC Socket

LCC Sockets

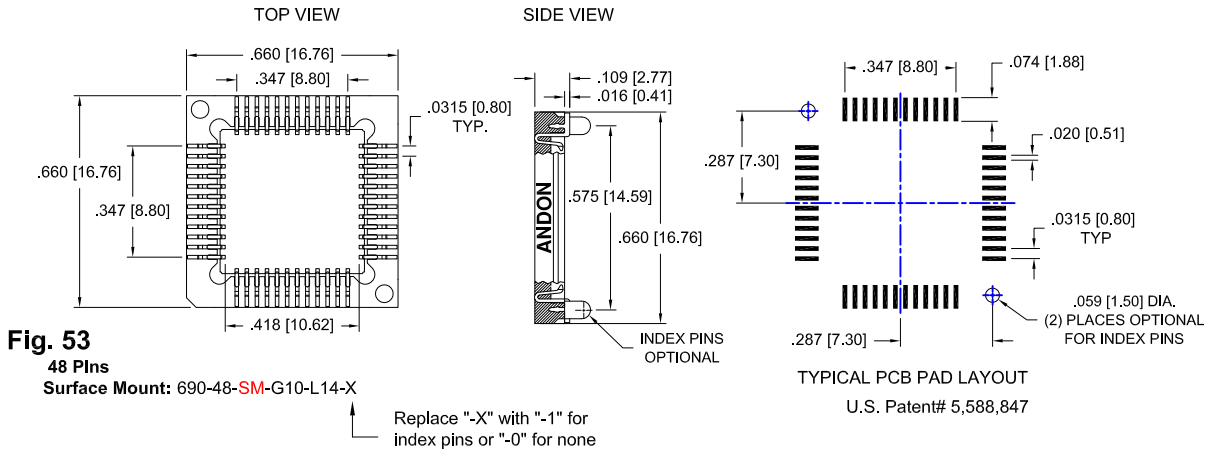

Fig. 53
48 Pins
Surface Mount: 690-48-SM-G10-L14-X
Replace "-X" with "-1" for index pins or "-0" for none

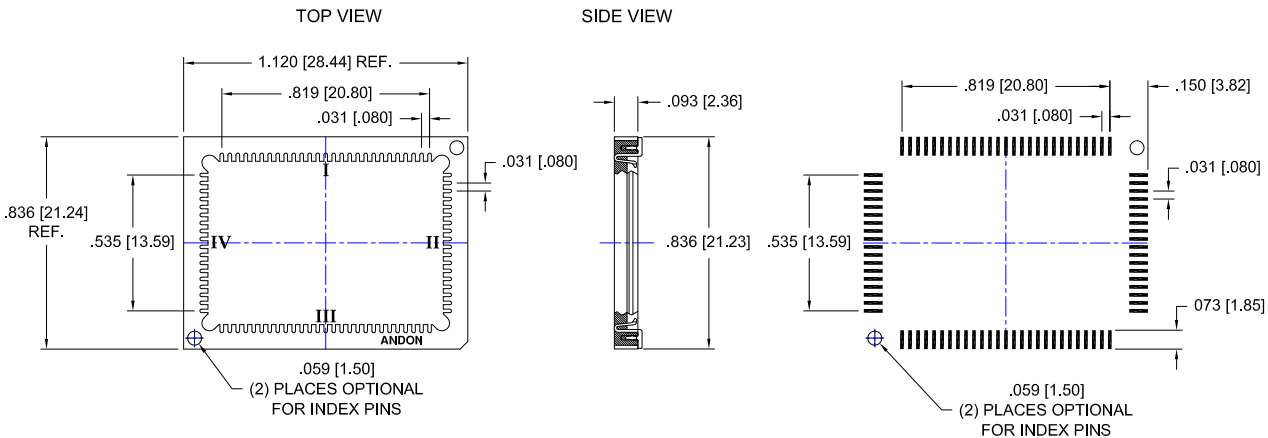
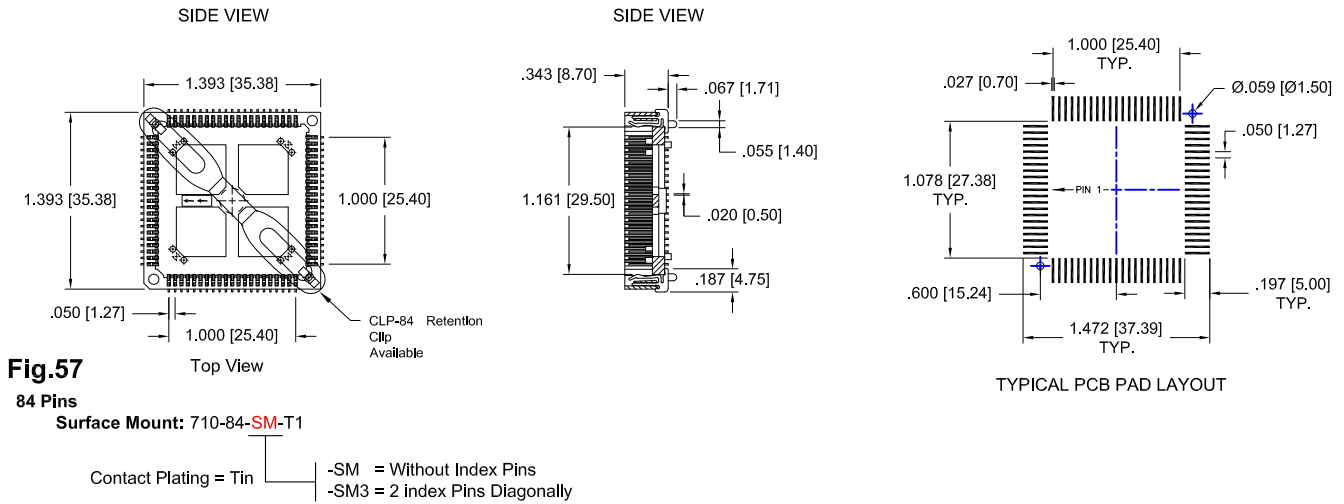

Fig. 70
90 Pins
Surface Mount: 690-90-SM-G10-L14-X
Replace "-X" with "-1" for index pins or "-0" for none

For Other Pin Configuration or Layouts, Contact Factory.

.050 [1.27] Pitch PLCC Socket



LCC Sockets

Image Sensor LCC Sockets [For a full product data sheet, contact us.] **EXTRACTION TOOL AVAILABLE**

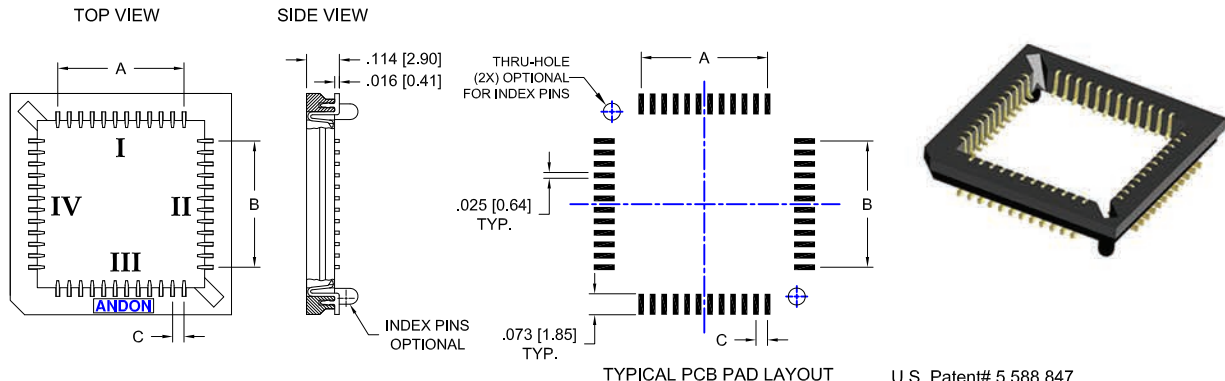

Andon Part Number	Figure Number	Pin QTY.	A	B	C	Number of Pins (per side)			
						I	II	III	IV
620-20B-SM-G10-S14-X	23	20	.200 (5.08)	.200 (5.08)	.050 (1.27)	5	5	5	5
620-28-SM-G10-L14-X	23	28	.300 (7.62)	.300 (7.62)	.050 (1.27)	7	7	7	7
620-40A-SM-G10-L14-X	23	40	.950 (24.13)	.950 (24.13)	.050 (1.27)	20	0	20	0
620-44-SM-G10-L14-X	23	44	.500 (12.70)	.500 (12.70)	.050 (1.27)	11	11	11	11
620-52-SM-G10-L14-X	23	52	.600 (15.24)	.600 (15.24)	.050 (1.27)	13	13	13	13
620-68-SM-G10-S14-X	23	68	.800 (20.32)	.800 (20.32)	.050 (1.27)	17	17	17	17
620-84-SM-G10-L14-X	23	84	1.000 (25.40)	1.000 (25.40)	.050 (1.27)	21	21	21	21
620-100-SM-G10-L14-X	23	100	1.200 (30.48)	1.200 (30.48)	.050 (1.27)	25	25	25	25
680-32-SM-G10-L14-X	23	32	.280 (7.11)	.280 (7.11)	.040 (1.01)	8	8	8	8
680-40-SM-G10-L14-X	23	40	.360 (9.14)	.360 (9.14)	.040 (1.01)	10	10	10	10
680-44-SM-G10-L14-X	23	44	.520 (13.21)	.520 (13.21)	.040 (1.01)	11	11	11	11
680-48-SM-G10-R14-X	23	48	.440 (11.18)	.440 (11.18)	.040 (1.01)	12	12	12	12
680-64-SM-G10-R14-X	23	64	.600 (15.24)	.600 (15.24)	.040 (1.01)	16	16	16	16
680-84-SM-G10-L14-X	23	84	.800 (20.32)	.800 (20.32)	.040 (1.01)	21	21	21	21
680-100-SM-G10-L14-X	23	100	1.120 (28.45)	.800 (20.32)	.040 (1.01)	29	21	29	21

Replace "-X" with "-1" for index pins or "-0" for none

CHART IS FOR REFERENCE ONLY. CONTACT FACTORY FOR ACTUAL SOCKET DWG. AND PCB LAYOUT.

OTHER LCC SOCKETS AVAILABLE

For Other Pin Configuration or Layouts, Contact Factory.

Appendix A: Terminal Details

Cross Section View Shown

Units: in [mm]

Terminals

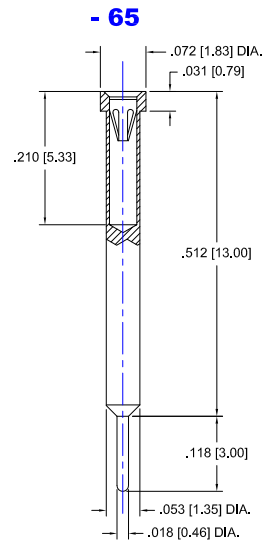
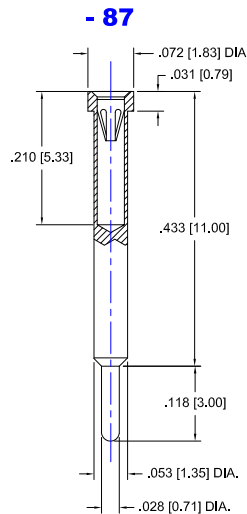
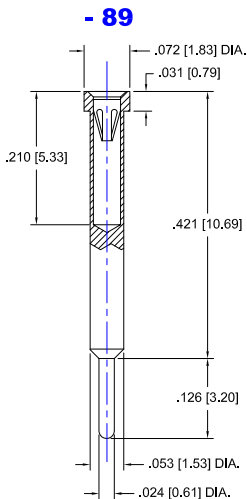
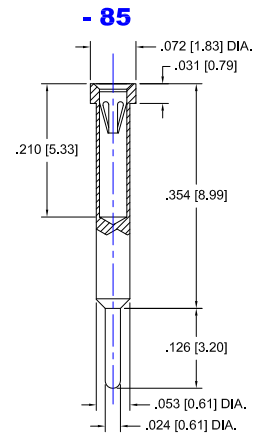
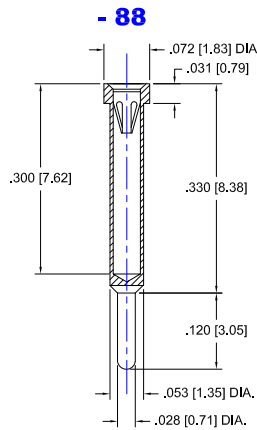
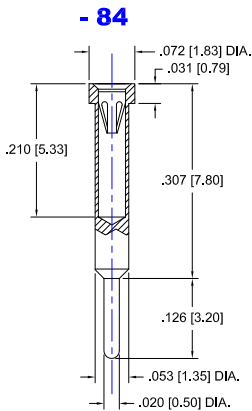
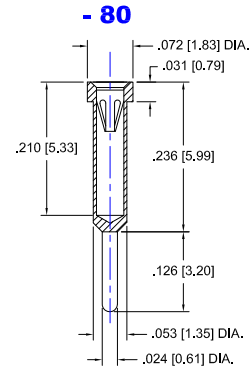
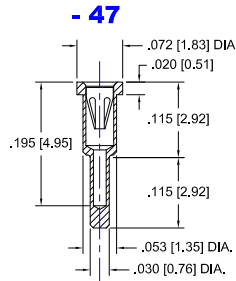
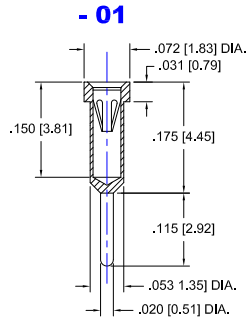

For Other Pin Configuration or Layouts, Contact Factory.

©Copyright 2013 Andon Electronics Corporation. All Rights Reserved. This material is protected under US and other copyrights and may not be copied, sold, or redistributed in any form without written permission of Andon Electronics Corporation. Copyrights and trademarks are property of their respective companies. We reserve the right to change specifications without notice. Andon makes no warranty, expressed or implied, as to the suitability of the sockets for the intended purpose.

RoHS Compliant
Andon Proprietary Information
IS-13A 03/15/13

Appendix A: Terminal Details
Cross Section View Shown
Units: in [mm]

Terminals

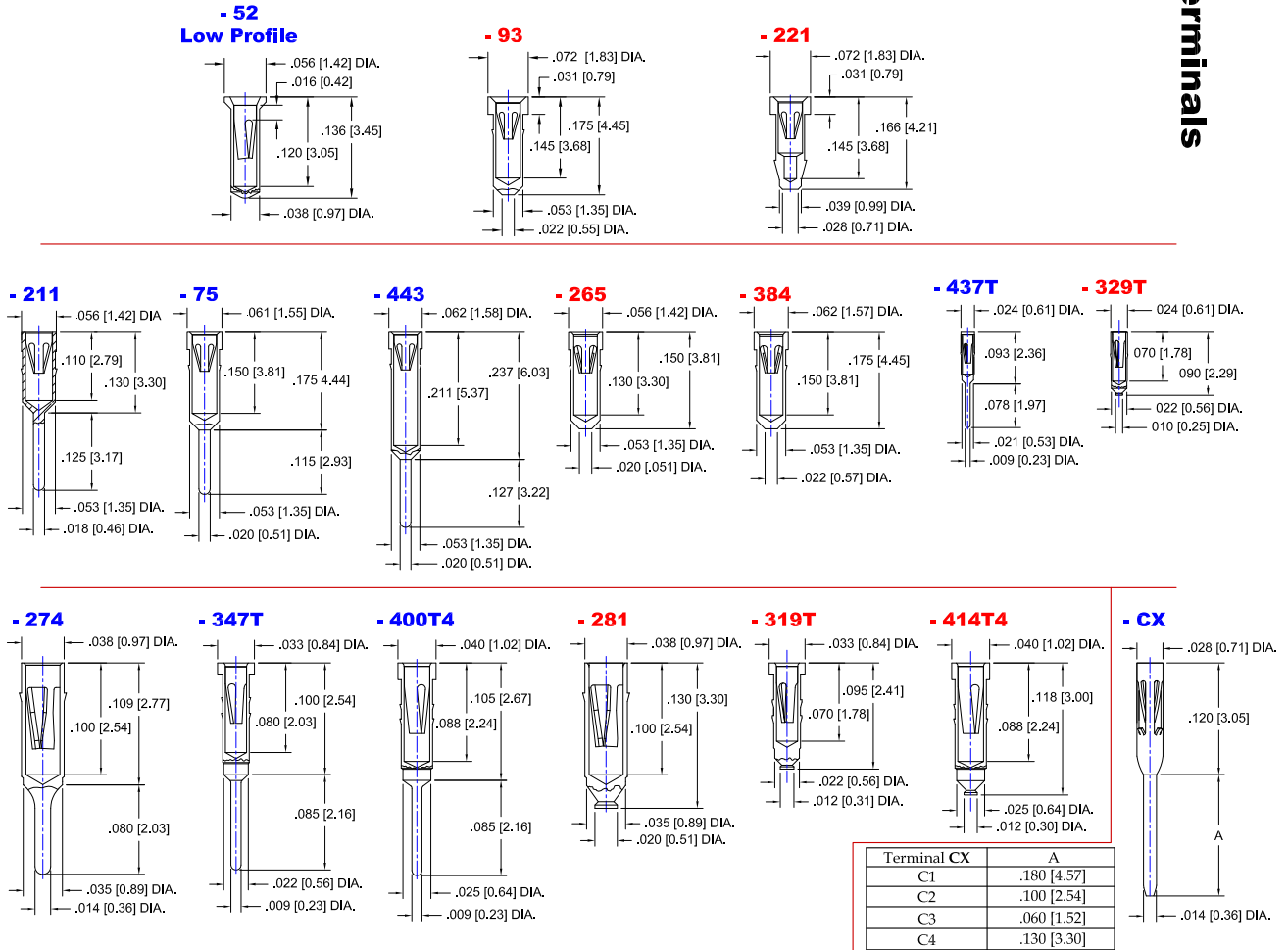

ROLLERBALL® TERMINAL STYLES

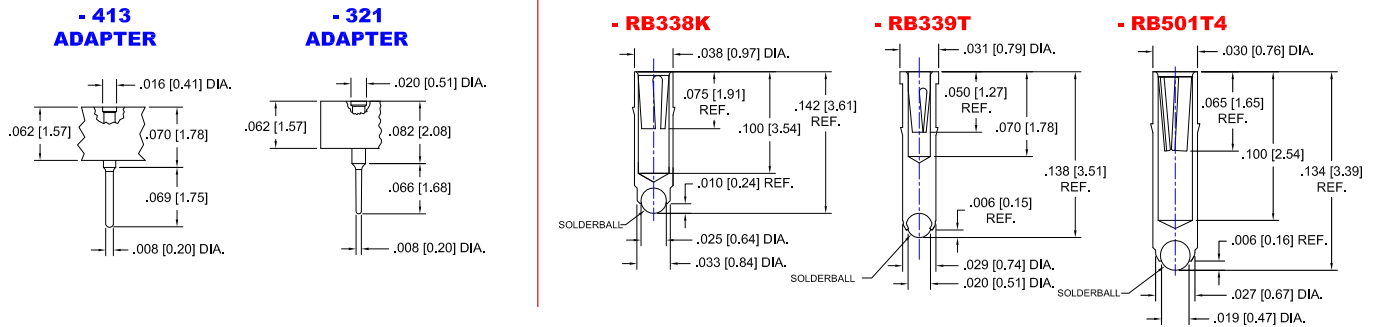

CONTACT TYPE

T: Dip / Sip

insertion force 1.0 oz max
withdrawal force 0.3 oz min

T4: Dip / Sip

insertion force 1.05 oz max
withdrawal force 0.32 oz min

U: Dip / Sip

insertion force 2.8 oz avg
withdrawal force 0.5 oz min

K: Dip / Sip

insertion force 1.2 oz max
withdrawal force 0.4 oz min

S: Dip / Sip

insertion force 9.0 oz avg
withdrawal force 2.0 oz min

M:

insertion force 1.6 oz max
withdrawal force 0.5 oz min

H: High Force

insertion force 18.3 oz avg
withdrawal force 4.2 oz min

C1, C2, C3, and C4:

insertion force 1.5 oz avg
withdrawal force .35 oz min

For Other Pin Configuration or Layouts, Contact Factory.

[Back to Table of Contents](#)

Index

Andon Part Number	Pin QTY.	Page No.	Figure Number
10-14-11-097-400T4-R27-L14	97	23	4
10-21-06-369-400T4-R27-L14	369	23	55
10-24-05-168-347T-R27-L14	168	22	5
10-24-05A-168-400T4-R27-L14	168	22	58
10-30-07-237-400T4-R27-L14	237	22	48
10-30-07A-237-400T4-R27-L14	237	22	59
10-31-13-355-400T4-R27-L14	355	22	56
10-31-13A-355-400T4-R27-L14	355	22	60
12-08-02-052-347T-R27-L14	52	24	51
12-08-02-052-321-R27-L14	52	24	51
18-07-03-041-437T-R27-L14	41	24	50
405-03-01S-R29-L14	3	15	10
405-03-80S-R29-L14	3	15	10
405-04-01S-R29-L14	4	15	10
405-04-80S-R29-L14	4	15	10
405-05-01S-R29-L14	5	15	10
405-05-80S-R29-L14	5	15	10
405-06-01S-R29-L14	6	15	10
405-06-80S-R29-L14	6	15	10
405-07-01S-R29-L14	7	15	10
405-07-80S-R29-L14	7	15	10
405-08-01S-R29-L14	8	15	10
405-08-80S-R29-L14	8	15	10
405-09-01S-R29-L14	9	15	10
405-09-80S-R29-L14	9	15	10
405-10-01S-R29-L14	10	15	10
405-10-80S-R29-L14	10	15	10
405-11-01S-R29-L14	11	15	10
405-11-80S-R29-L14	11	15	10
405-11-88S-R29-L14	11	15	10
405-12-01S-R29-L14	12	15	10
405-12-80S-R29-L14	12	15	10
405-13-01S-R29-L14	13	15	10
405-13-80S-R29-L14	13	15	10
405-14-01S-R29-L14	14	15	10
405-14-80S-R29-L14	14	15	10
405-14-88S-R29-L14	14	15	10
405-15-01S-R29-L14	15	15	10
405-15-80S-R29-L14	15	15	10
405-16-01S-R29-L14	16	15	10
405-16-80S-R29-L14	16	15	10
405-17-01S-R29-L14	17	15	10
405-17-80S-R29-L14	17	15	10
405-18-01S-R29-L14	18	15	10
405-18-80S-R29-L14	18	15	10
405-19-01S-R29-L14	19	15	10
405-19-80S-R29-L14	19	15	10
405-20-01S-R29-L14	20	15	10
405-20-80S-R29-L14	20	15	10
405-21-01S-R29-L14	21	15	10
405-21-80S-R29-L14	21	15	10
405-22-01S-R29-L14	22	15	10
405-22-80S-R29-L14	22	15	10
405-23-01S-R29-L14	23	15	10
405-23-80S-R29-L14	23	15	10
405-24-01S-R29-L14	24	15	10
405-24-80S-R29-L14	24	15	10
405-25-01S-R29-L14	25	15	10
405-25-80S-R29-L14	25	15	10
405-26-01S-R29-L14	26	15	10
405-26-80S-R29-L14	26	15	10
405-27-01S-R29-L14	27	15	10
405-27-80S-R29-L14	27	15	10
405-28-01S-R29-L14	28	15	10
405-28-80S-R29-L14	28	15	10
405-29-01S-R29-L14	29	15	10
405-29-80S-R29-L14	29	15	10
405-30-01S-R29-L14	30	15	10
405-30-80S-R29-L14	30	15	10
409-209-01S-R29-L14	18	14	11
409-210-80S-R29-L14	20	14	11
409-211-01S-R29-L14	22	14	11
409-213-80S-R29-L14	26	14	11
416-03-75S-R29-L14	3	20	12

Andon Part Number	Pin QTY.	Page No.	Figure Number
416-04-75S-R29-L14	4	20	12
416-05-75S-R29-L14	5	20	12
416-06-75S-R29-L14	6	20	12
416-07-75S-R29-L14	7	20	12
416-08-75S-R29-L14	8	20	12
416-09-75S-R29-L14	9	20	12
416-10-75S-R29-L14	10	20	12
416-11-75S-R29-L14	11	20	12
416-12-75S-R29-L14	12	20	12
416-13-75S-R29-L14	13	20	12
416-14-75S-R29-L14	14	20	12
416-15-75S-R29-L14	15	20	12
416-16-75S-R29-L14	16	20	12
416-17-75S-R29-L14	17	20	12
416-18-75S-R29-L14	18	20	12
416-19-75S-R29-L14	19	20	12
416-20-75S-R29-L14	20	20	12
416-21-75S-R29-L14	21	20	12
416-22-75S-R29-L14	22	20	12
416-23-75S-R29-L14	23	20	12
416-24-75S-R29-L14	24	20	12
416-25-75S-R29-L14	25	20	12
416-26-75S-R29-L14	26	20	12
416-27-75S-R29-L14	27	20	12
416-28-75S-R29-L14	28	20	12
416-29-75S-R29-L14	29	20	12
416-30-75S-R29-L14	30	20	12
417-05-274U-R27-L14	5	21	13
417-06-274U-R27-L14	6	21	13
417-07-274U-R27-L14	7	21	13
417-08-274U-R27-L14	8	21	13
417-09-274U-R27-L14	9	21	13
417-10-274U-R27-L14	10	21	13
417-11-274U-R27-L14	11	21	13
417-12-274U-R27-L14	12	21	13
417-13-274U-R27-L14	13	21	13
417-14-274U-R27-L14	14	21	13
417-15-274U-R27-L14	15	21	13
417-16-274U-R27-L14	16	21	13
417-17-274U-R27-L14	17	21	13
417-18-274U-R27-L14	18	21	13
417-19-274U-R27-L14	19	21	13
417-20-274U-R27-L14	20	21	13
417-21-274U-R27-L14	21	21	13
417-22-274U-R27-L14	22	21	13
417-23-274U-R27-L14	23	21	13
417-24-274U-R27-L14	24	21	13
417-25-274U-R27-L14	25	21	13
417-26-274U-R27-L14	26	21	13
417-27-274U-R27-L14	27	21	13
417-28-274U-R27-L14	28	21	13
417-29-274U-R27-L14	29	21	13
417-30-274U-R27-L14	30	21	13
419-14-C4-G10-L14	14	23	69
575-08-04-040-80M-R29-L14	40	16	14
575-10-19-037-01S-R29-L14	37	17	30
575-11-42-068-01M-R29-L14	68	16	15
575-11-57-073-01M-R29-L14	73	16	16
575-12-22-044-88M-R29-L14	44	16	17
575-13-83-048-80M-R29-L14	48	16	18
575-14-39-036-01S-R29-L14	36	17	29
575-15-28-145-01M-R29-L14	145	17	36
575-15-62-082-80M-R29-L14	82	16	19
575-15-63-080-01M-R29-L14	80	16	20
575-15-64-056-88M-R29-L14	56	16	21
575-15-65-084-01M-R29-L14	84	16	24
575-16-24-127-01M-R29-L14	127	17	35
575-16-25-060-88M-R29-L14	60	17	32
575-16-26-032-01S-R29-L14	32	17	46
575-19-25-281-01M-R29-L14	281	17	33
575-19-27-088-01M-R29-L14	88	17	27
575-20-16-096-01M-R29-L14	96	16	22
575-21-14-168-80M-R29-L14	168	16	61
575-23-02-104-01M-R29-L14	104	17	28

For Other Pin Configuration or Layouts, Contact Factory.

©Copyright 2013 Andon Electronics Corporation. All Rights Reserved. This material is protected under US and other copyrights and may not be copied, sold, or redistributed in any form without written permission of Andon Electronics Corporation. Copyrights and trademarks are property of their respective companies. We reserve the right to change specifications without notice. Andon makes no warranty, expressed or implied, as to the suitability of the sockets for the intended purpose.

RoHS Compliant
Andon Proprietary Information
IS-13A 03/15/13

[Back to Table of Contents](#)

Andon Part Number	Pin QTY.	Page No.	Figure Number
575-23-03-072-01M-R29-L14	72	16	62
575-25-04-080-01M-R29-L14	80	16	25
575-40-02-104-01M-R29-L14	104	17	26
585-07-02-034-211M-R29-L14	34	23	31
585-18-12-046-211M-R29-L14	46	23	64
620-100-SM-G10-L14-X	100	25	23
620-28-SM-G10-L14-X	28	25	23
620-40A-SM-G10-L14-X	40	25	23
620-44-SM-G10-L14-X	23	25	23
620-52-SM-G10-L14-X	52	25	23
620-68-SM-G10-L14-X	68	25	23
620-84-SM-G10-L14-X	84	25	23
620-100-SM-G10-L14-X	100	25	23
680-32-SM-G10-L14-X	32	25	23
680-40-SM-G10-L14-X	40	25	23
680-44-SM-G10-L14-X	44	25	23
680-48-SM-G10-R14-X	48	25	23
680-64-SM-G10-R14-X	64	25	23
680-84-SM-G10-R14-X	84	25	23
680-100-SM-G10-R14-X	100	25	23
685-48-TH-491-R27-L14-X	48	24	52
690-48-SM-G10-L14-1	48	24	53
690-90-SM-G10-L14-1	48	24	70
710-84-SM-T1	84	25	57
IS229-306-01S-R29-L14	6	12	1
IS229-308-01S-R29-L14	8	12	1
IS229-316-01S-R29-L14	16	12	1
IS229-318-01S-R29-L14	18	12	1
IS229-324-01S-R29-L14	24	12	1
IS229-408-01S-R29-L14	8	12	1
IS229-420-01S-R29-L14	20	12	1
IS229-422-01S-R29-L14	22	12	1
IS229-422-80S-R29-L14	22	12	1
IS229-422-88S-R29-L14-A	22	13	1A
IS229-424-80S-R29-L14	24	12	1
IS229-424-400T4-R29-L14	24	12	1
IS229-432-80S-R29-L14	32	12	1
IS229-620-01S-R29-L14	20	12	1
IS229-622-01S-R29-L14	22	12	1
IS229-624-01S-R29-L14	24	12	1
IS229-624-80S-R29-L14	24	12	1
IS229-628-80S-R29-L14	28	12	1
IS229-640-01M-R29-L14	40	12	1
IS229-648-01M-R29-L14	48	12	1
IS229-650-01M-R29-L14	50	12	1
IS229-656-01M-R29-L14	56	12	1
IS229-722-80S-R29-L14-A	22	13	1A
IS229-780D-01M-R29-L14-A	80	14	3
IS229-820-80S-R29-L14	20	12	1
IS229-820-80S-R29-L14-A	20	13	1A
IS229-824-01S-R29-L14	24	12	1
IS229-824-01S-R29-L14-A	24	13	1A
IS229-826-01S-R29-L14	26	12	1
IS229-828-88S-R29-L14	28	12	1
IS229-840-01M-R29-L14	40	12	1
IS229-924-01S-R29-L14	24	12	1
IS229-932-01S-R29-L14	32	12	1
IS229-938-01S-R29-L14	38	12	1
IS229-940-01M-R29-L14	40	12	1
IS229-944-01M-R29-L14	44	12	1
IS229-1028-01S-R29-L14-A	28	13	1A
IS229-1060D-01M-R29-L14	60	14	3
IS229-1226-80S-R29-L14	26	12	1
IS229-1330-01M-R29-L14	30	12	1
IS229-1426-01S-R29-L14	26	12	1
IS229-1451D-80M-R29-L14-A	51	14	2
IS229-1536D-01S-R29-L14	36	14	3
IS229-1639D-80M-R29-L14	39	14	3
IS229-1644D-01M-R29-L14	44	14	3
IS229-1752D-01M-R29-L14	52	13	39
IS229-1824-80S-R29-L14	24	12	1
IS229-1944D-01M-R29-L14	44	14	3
IS229-2024-80S-R29-L14	24	12	1
IS229-2034-80S-R29-L14	34	12	1

Andon Part Number	Pin QTY.	Page No.	Figure Number
IS229-2044-80M-R29-L14	44	12	1
IS229-2639-01S-R29-L14	39	13	61
IS229-2278T-01M-R29-L14	78	13	42
IS229-2488D-01M-R29-L14	88	14	3
IS229-2640-01M-R29-L14-SIP	40	12	1
IS229-2654-01M-R29-L14-SIP	54	12	1
IS229-3080D-01M-R29-L14	80	14	3
IS229-39524-01S-R29-L14	24	12	1
IS229-6120-80S-R29-L14	20	12	1
IS229-6124-01S-R29-L14	24	12	1
IS229-6128-01S-R29-L14	28	12	1
IS229-6140-01M-R29-L14	40	12	1
IS229-8176D-01M-R29-L14-A	176	15	65
IS229-8824-01S-R29-L14	24	12	1
IS229-8826-01S-R29-L14	26	12	1
IS229-8826-80S-R29-L14	26	12	1
IS229-9124-80S-R29-L14	24	12	1
IS229-10264T-01M-R29-L14-A	264	15	66
IS230-416-75S-R29-L14	16	18	6
IS230-420-75S-R29-L14	20	18	6
IS230-532-75S-R29-L14	32	18	6
IS230-620-75S-R29-L14	20	18	6
IS230-620-75S-R29-L14-A	20	18	6A
IS230-624-75S-R29-L14-B	24	19	6B
IS230-632-75S-R29-L14	32	18	6
IS230-724-75S-R29-L14-A	24	18	6A
IS230-828-75S-R29-L14	28	18	6
IS230-832-75S-R29-L14	32	18	6
IS230-832-75S-R29-L14-A	32	18	6A
IS230-832-75S-R29-L14-B	32	19	6B
IS230-930-75S-R29-L14	30	18	6
IS230-934-75S-R29-L14	34	18	6
IS230-938-01S-R29-L14	38	12	1
IS230-976D-75M-R29-L14-A	73	19	40
IS230-1034-75S-R29-L14	34	18	6
IS230-1034-75S-R29-L14-A	34	18	6A
IS230-1232-400T4-R29-L14	32	18	6
IS230-1232-75S-R29-L14	32	18	6
IS230-1340-75M-R29-L14	40	18	6
IS230-1371D-75M-R29-L14-A	71	19	54
IS230-2064-75M-R29-L14	64	18	6
IS230-2640-75M-R29-L14	40	18	6
IS230-4512-75S-R29-L14	12	18	6
IS230-6367D-75M-R29-L14-A	67	19	38
IS230-18860-75M-R29-L14	64	18	6
IS230D-13138-75M-R29-L14-A	138	20	68
IS230D-6968SP-443M-R29-L14-A	68	18	67
IS230D-97134-75M-R29-L14-A	134	20	41
IS230T-13205-75M-R29-L14-A	205	20	61
IS231-428-01S-R29-L14	28	13	7
IS231-622-01S-R29-L14	22	13	7
IS231-636-01S-R29-L14	36	13	7
IS231-644-80M-R29-L14	44	13	7
IS231-1040A-01M-R29-L14	40	14	43
IS231-1149D-01M-R29-L14	49	14	37
IS231-2054D-01M-R29-L14-A	54	16	63
IS231-6140-01M-R29-L14	40	13	7
IS232-316-274U-R27-L14	16	21	8
IS232-414-274U-R27-L14	14	21	8
IS232-416-274U-R27-L14	16	21	8
IS232-440-274U-R27-L14	40	21	8
IS232-520-274U-R27-L14	20	21	8
IS232-522-274U-R27-L14	22	21	8
IS232-622-274U-R27-L14	22	21	8
IS232-628-274U-R27-L14	28	21	8
IS232-4516-274U-R27-L14	16	21	8
IS232-4820-274U-R27-L14	20	21	8
IS232-5724-274U-R27-L14	24	21	8
IS233-424-75S-R29-L14	24	19	9
IS233-532-75S-R29-L14	32	19	9
IS233-4146-75M-R29-L14	46	19	9
ISO437SP-418-C4-G10-L14	18	23	45
ISO437SP-5728-C4-G10-L14	28	23	44
R225-1413-01N-400T4-R27-L14	13	23	34

Index

For Other Pin Configuration or Layouts, Contact Factory.

©Copyright 2013 Andon Electronics Corporation. All Rights Reserved. This material is protected under US and other copyrights and may not be copied, sold, or redistributed in any form without written permission of Andon Electronics Corporation. Copyrights and trademarks are property of their respective companies. We reserve the right to change specifications without notice. Andon makes no warranty, expressed or implied, as to the suitability of the sockets for the intended purpose.

RoHS Compliant
Andon Proprietary Information
IS-13A 03/15/13

1 mm (.0394 inch) Pitch BGA Sockets / Adapters Rollerball® Grid Array Socketing System

THE IDEAL SOLUTION TO FIX BGA ASSEMBLY PROBLEMS ON LARGE PCB'S

- ADAPTER WITH TERMINAL PINS FOR PLUGGING INTO ROLLERBALL® SOCKET. BGA SOLDERED DIRECTLY ONTO ADAPTER.
- SOCKET WITH ROLLERBALL® TERMINALS FOR SOLDERING DIRECTLY ONTO PCB.
- REWORK COST AND RISK OF DAMAGE REDUCED TO EXPENSIVE BGA AND MULTI LAYER PCB'S.

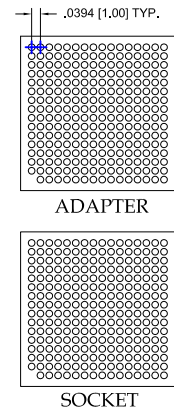
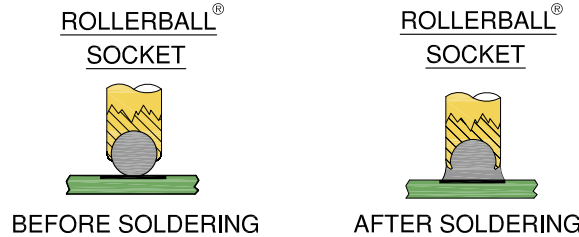
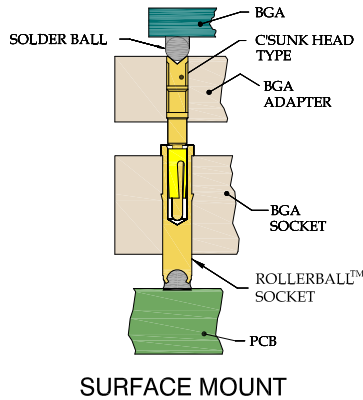

ROLLERBALL® GRID ARRAY
SOCKETING ASSEMBLY
U.S. Patent # 6,352,437
Canadian Patent # 2,388,520

.0394 [1.00] X .0394 [1.00] PITCH
MANY FOOTPRINTS AVAILABLE

TERMINAL STYLES

OTHER TERMINAL STYLES AVAILABLE (CONSULT FACTORY)

ADAPTER TERMINAL

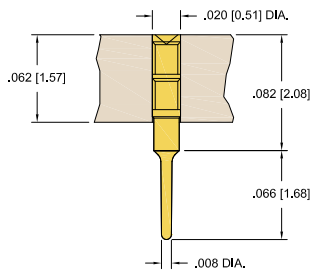

-320 C'SUNK HEAD
-321 FLATHEAD

SOCKET TERMINAL

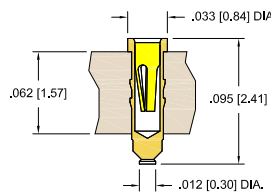

-319T SURFACE MOUNT

SOCKET TERMINAL

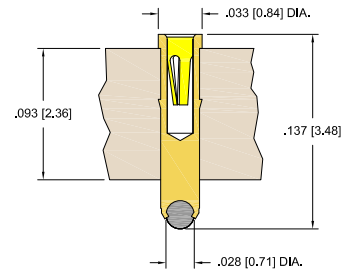

-RB339T SURFACE MOUNT ROLLERBALL®

TECHNICAL SPECIFICATIONS

MATERIAL:
INSULATOR: FR-4 LAMINATE U.L. RATED 94V-0
TERMINAL: BRASS PLATED GOLD
CONTACT: BeCu PLATED GOLD
SOLDERBALL: 96.5% TIN, 3.0% SILVER, 0.5% COPPER
ADAPTER: COPPER ALLOY PLATED GOLD

ORDERING INFORMATION

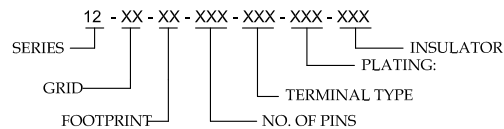

For Other Pin Configuration or Layouts, Contact Factory.

RoHS Compliant
Andon Proprietary Information
IS-13A 03/15/13

At Andon Electronics we provide interconnection components that help companies to cost effectively protect, assemble, test and replace their semiconductor devices.



- PGA SOCKETS & ADAPTERS
- BGA SOCKETS & ADAPTERS
- SMD SOCKETS & ADAPTERS
- DIP SOCKETS & ADAPTERS
- SIP SOCKETS & ADAPTERS
- FUSE SOCKETS
- TERMINALS AND TEST JACKS
- LCC SOCKETS
- PLCC SOCKETS
- IMAGE SENSOR SOCKETS
- GAS SENSOR SOCKETS
- OPTOELECTRONIC SOCKETS
- CARRIER SOCKETS
- BATTERY SOCKETS
- TEST SOCKETS
- POWER CONVERTER SOCKETS

We offer custom as well as our standard catalog items.

Our intention is to be your one stop for all of your interconnection requirements.

Please visit our website at www.andonelect.com if you have any questions please do not hesitate to contact us.

Contact: Customer Service

Phone: (401) 333-0388

Fax: (401) 333-0287

Email: info@andonelect.com

For Other Pin Configuration or Layouts, Contact Factory.



Distributed Worldwide.



ANDON ELECTRONICS CORPORATION

4 Court Drive Lincoln, RI 02865 USA

Phone: 401-333-0388 Fax: 401-333-0287

Email: Info@andonelect.com

Visit us on the Web at www.andonelect.com
or www.andonelectronics.com